

Distributor  
 where technologies meet solutions  
 info@amstechnologies.com  
 www.amstechnologies-webshop.com  
 Contact us 

ITEM	Material	DESCRIPTION
1	LE4560	D-ZLAF52LAM
2	3420012	SUS 304L
3	3420002	SUS 304L

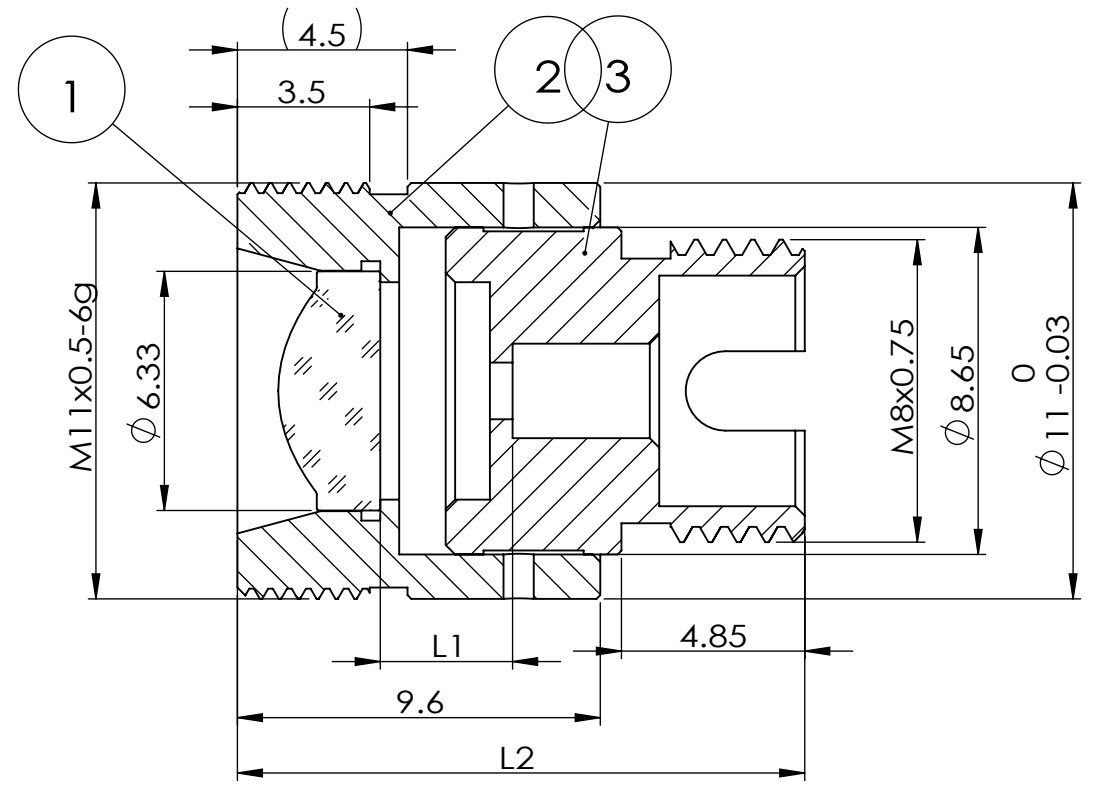

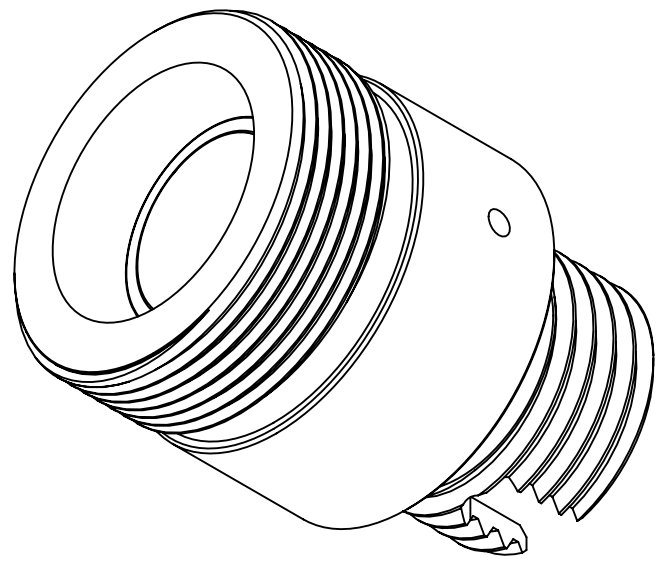
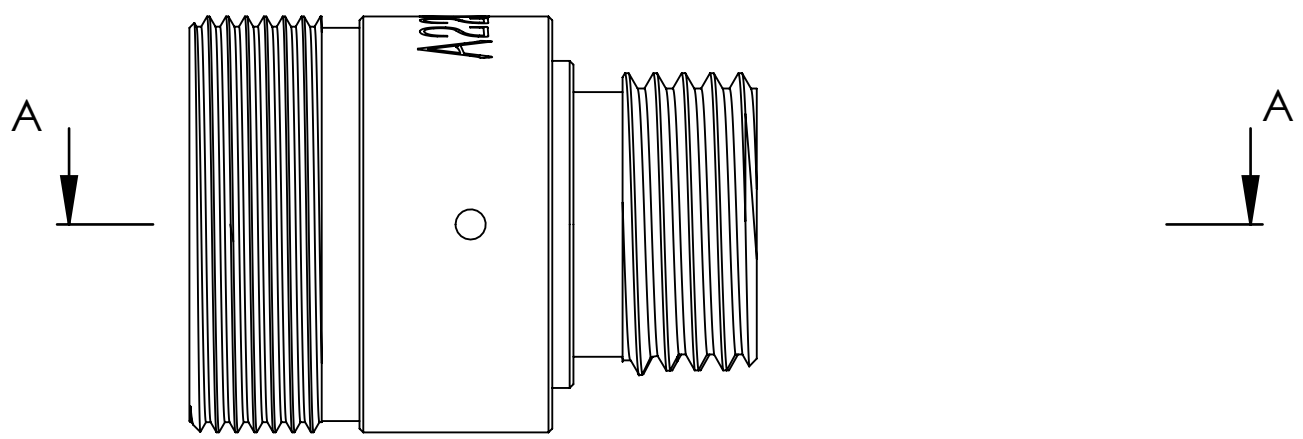

SECTION A-A

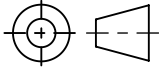

PART NUMBER	$\lambda$	ALIGNMENT FIBER	L1 (mm)	L2 $\pm 0.25$ (mm)
FE456020405	405nm	C405	2.78	14.29
FE456020532	532nm	460HP	2.91	14.42
FE456020633	633nm	SM600	2.96	14.47
FE456020780	780nm	780HP	3.00	14.51
FE456021064	1064nm	HI-1060	3.04	14.55
FE456021310	1310nm	SMF-28e	3.06	14.57
FE456021550	1550nm	SMF-28e	3.08	14.59

DO NOT SCALE DRAWING.

DRAWING PROJECTION. 

 **GH Optics (Jiangsu) Co., Ltd.**  
www.ghoptics.cn

TITLE: Connectorized Collimators with FC/PC

DWG NO. FE456020633

NAME	DATE
DRAWN	
CHK'D	
APPV'D	

UNIT: mm    SIZE: A3    SHEET 1 OF 1    REV. A