

Distributor  
  
 info@amstechnologies.com  
 www.amstechnologies-webshop.com  
**Contact us** 

ITEM	Material	DESCRIPTION
1	LDA130	D-ZK3M MOLDED ASPHERE
2	3420015	SUS 304L HOUSING
3	3420001	SUS 304L FC/APC CONNECTORS

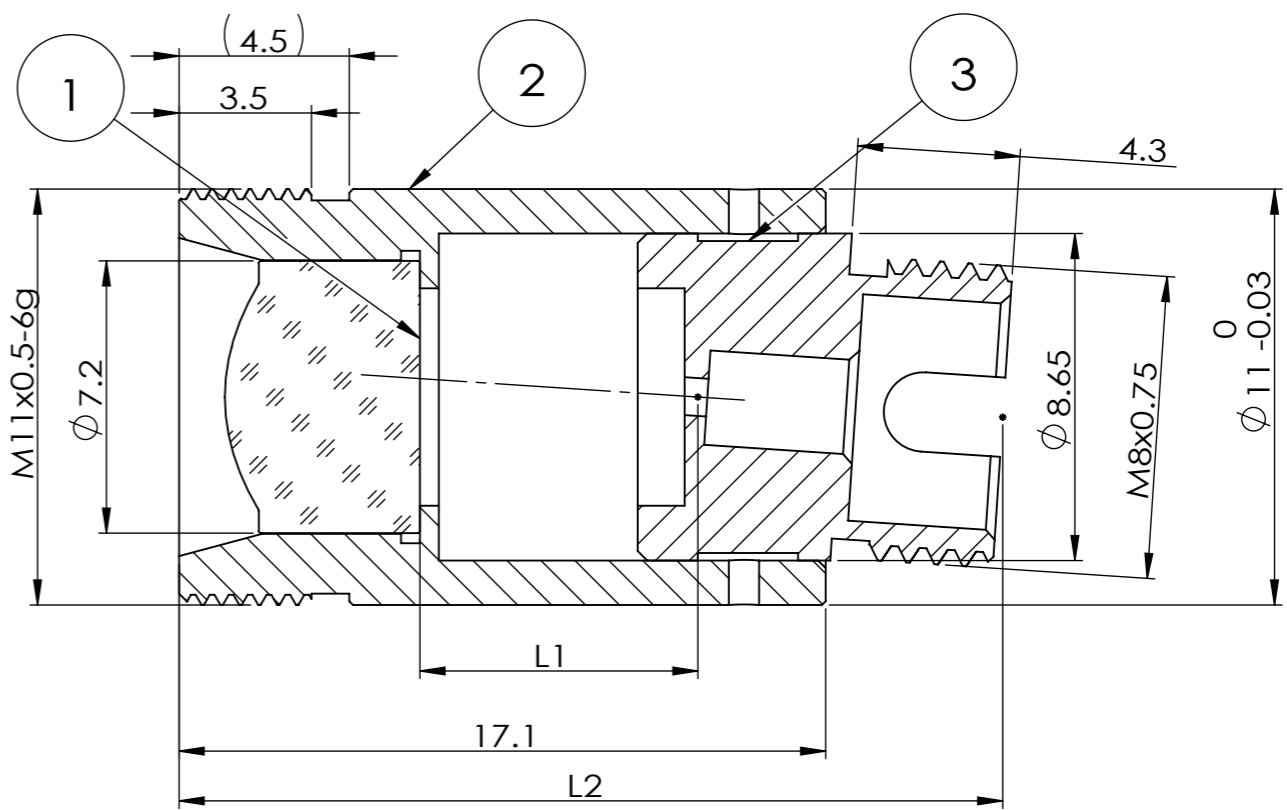

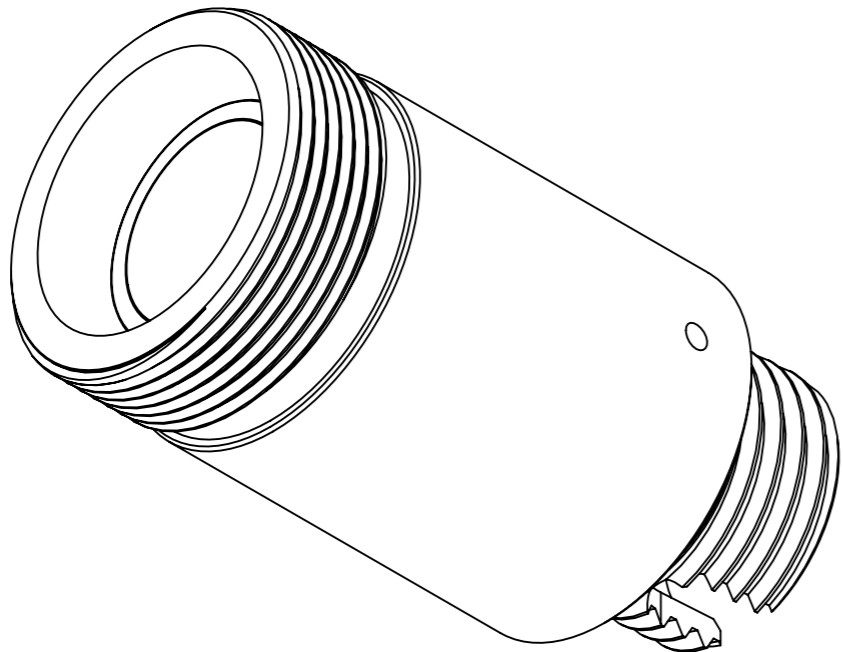
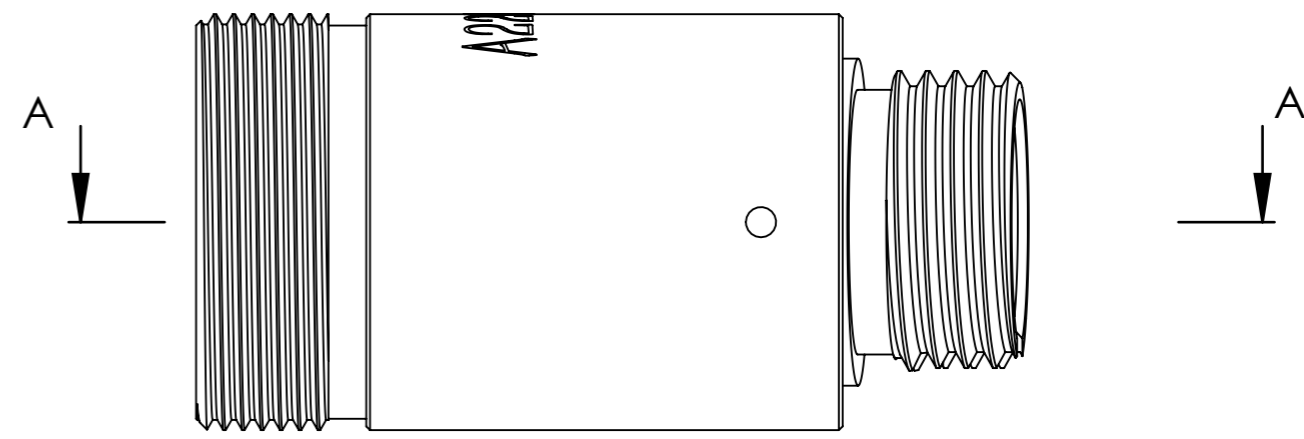

SECTION A-A

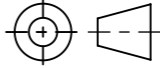

PART NUMBER	$\lambda$	ALIGNMENT FIBER	L1 (mm)	L2 $\pm 0.25$ (mm)
FDA13010405	405nm	C405	7.53	22.21
FDA13010532	532nm	460HP	7.74	22.42
FDA13010633	633nm	SM600	7.82	22.50
FDA13010780	780nm	780HP	7.90	22.58
FDA13011064	1064nm	HI 1060	7.99	22.67
FDA13011310	1310nm	SMF-28e	8.05	22.73
FDA13011550	1550nm	SMF-28e	8.11	22.79

DO NOT SCALE DRAWING.

DRAWING PROJECTION. 

 **GH Optics (Jiangsu) Co., Ltd.**  
www.ghoptics.cn

TITLE: Connectorized Collimators with FC/APC

DWG NO. **FDA13010405**

NAME	DATE
DRAWN	
CHK'D	
APPV'D	

UNIT: mm    SIZE: A3    SHEET 1 OF 1    REV. A