

Distributor

 info@amstechnologies.com
 www.amstechnologies-webshop.com
Contact us

ITEM	Material	DESCRIPTION
1 3420003	SUS 304L	SMA CONNECTORS
2 3420013	SUS 304L	HOUSING
3 LDA820	D-ZK3M	MOLDED ASPHERE

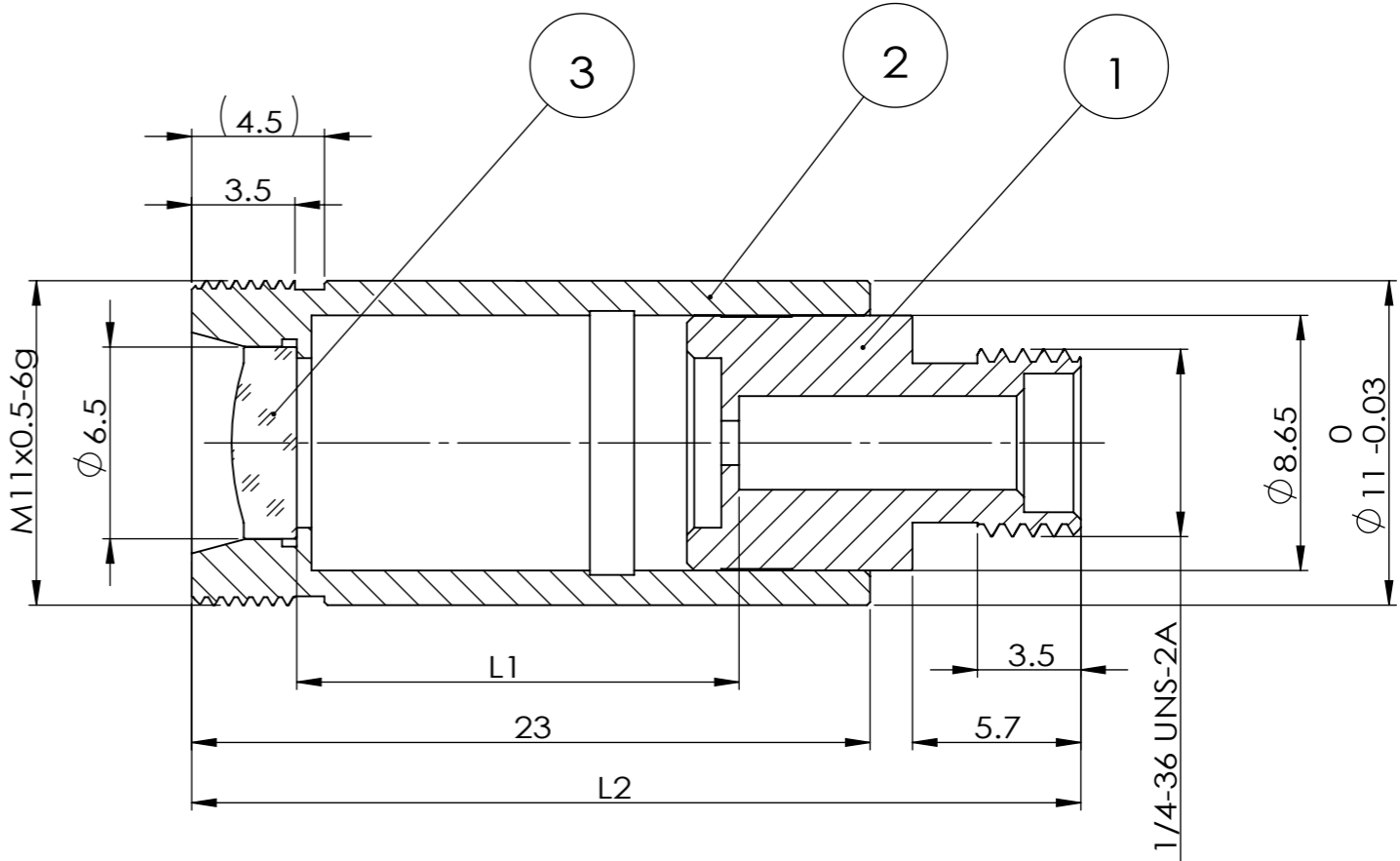

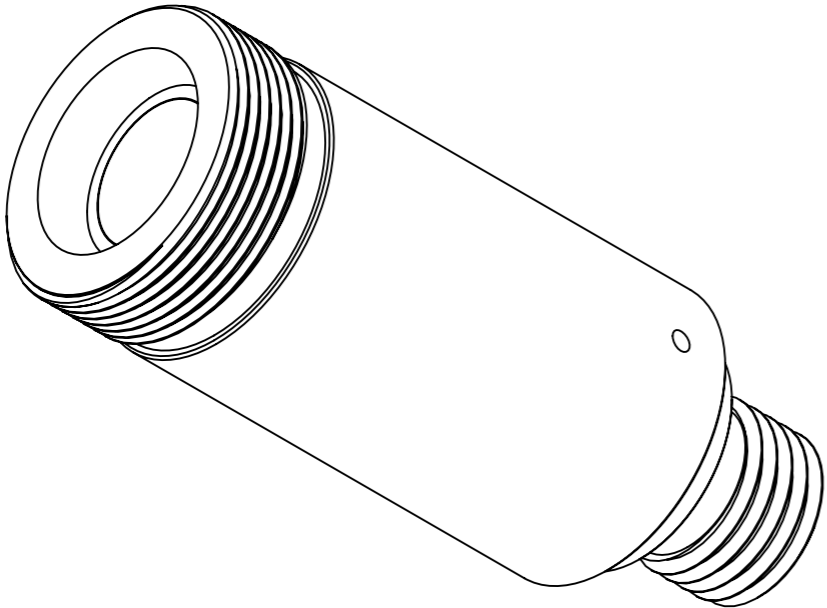

SECTION A-A

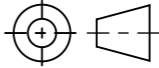

PART NUMBER	λ	ALIGNMENT FIBER	L1 (mm)	L2 ± 0.25 (mm)
FDA82030405	405nm	C405	16.34	31.49
FDA82030532	532nm	460HP	16.72	31.87
FDA82030633	633nm	SM600	16.88	32.03
FDA82030780	780nm	780HP	17.02	32.17
FDA82031064	1064nm	HI 1060	17.18	32.33
FDA82031310	1310nm	SMF-28e	17.30	32.45
FDA82031550	1550nm	SMF-28e	17.40	32.55

DO NOT SCALE DRAWING.

DRAWING PROJECTION. 

 **GH Optics (Jiangsu) Co., Ltd.**
www.ghoptics.cn

TITLE: Connectorized Collimators with SMA

DWG NO. FDA82030405

NAME	DATE
DRAWN	
CHK'D	
APPV'D	

UNIT: mm SIZE: A3 SHEET 1 OF 1 REV. A