

Distributor

 info@amstechnologies.com
 www.amstechnologies-webshop.com
Contact us 

ITEM	Material	DESCRIPTION
1	LDA820	D-ZK3M MOLDED ASPHERE
2	3420013	SUS 304L HOUSING
3	3420002	SUS 304L FC/PC CONNECTORS

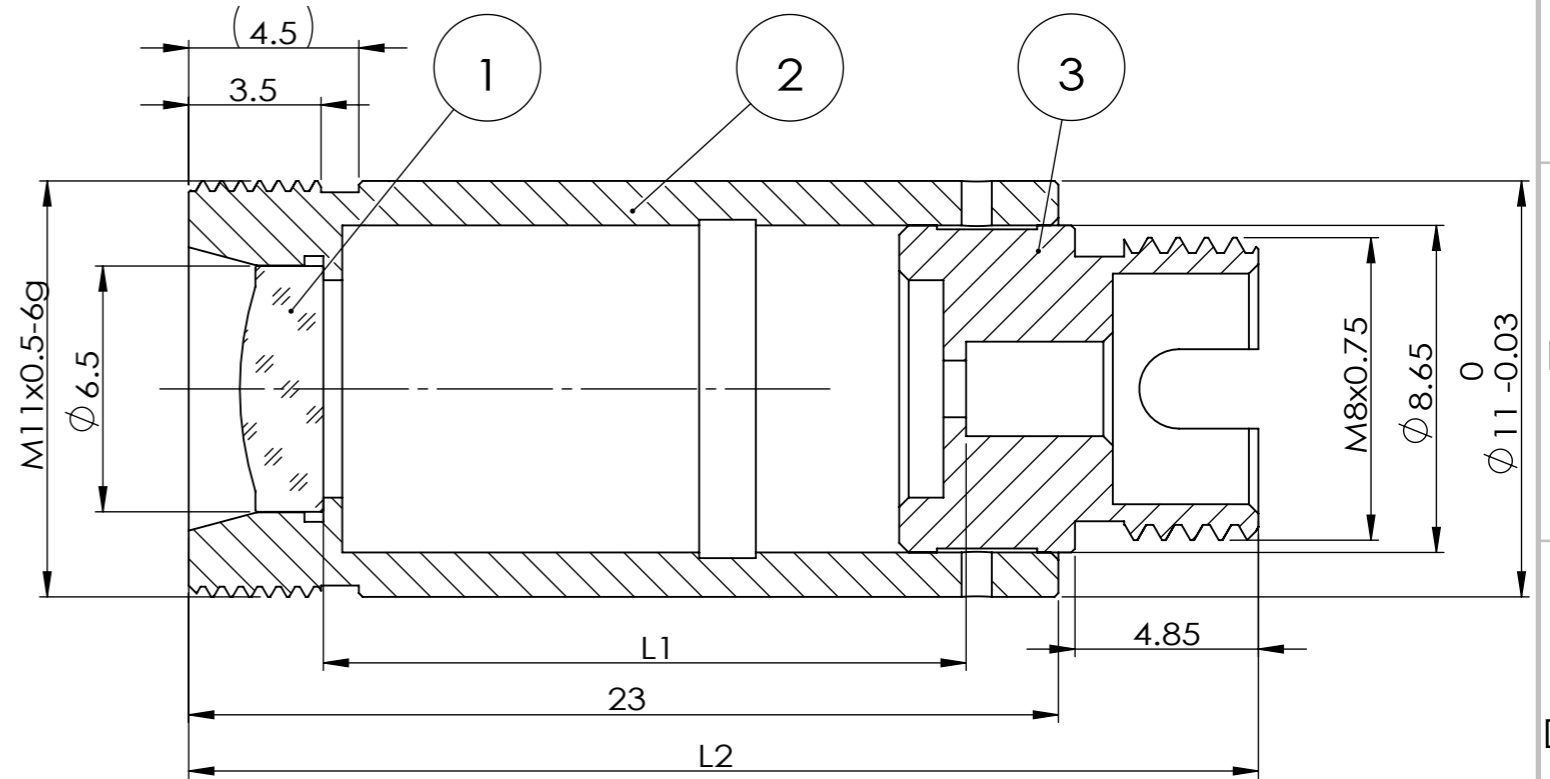

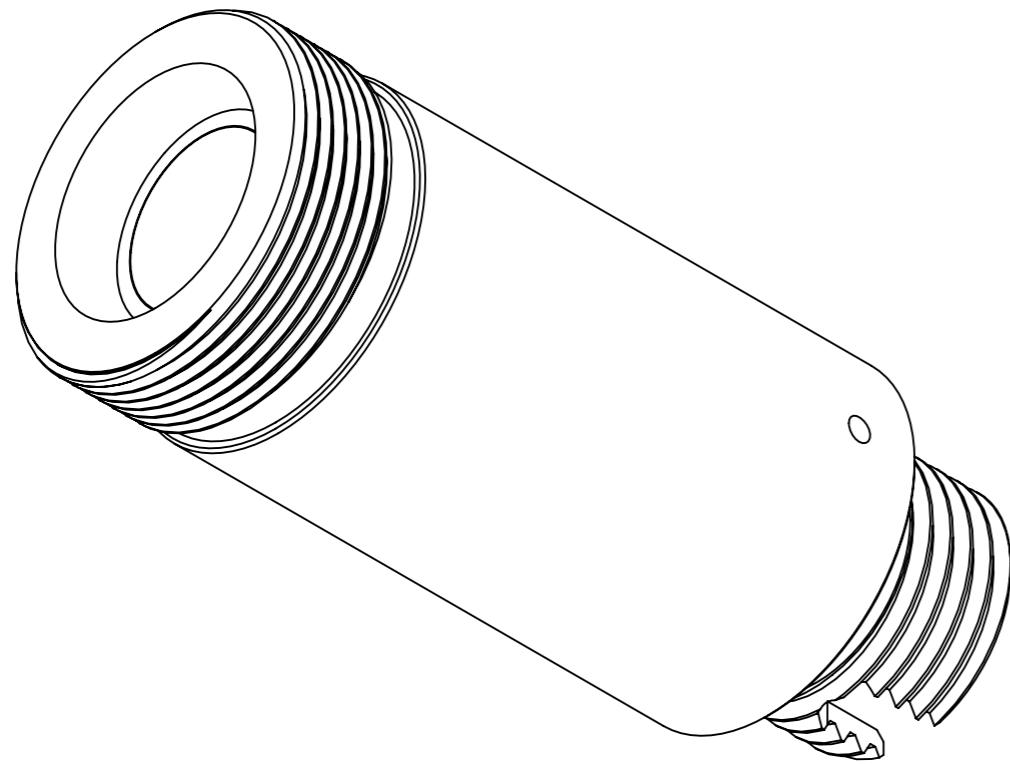

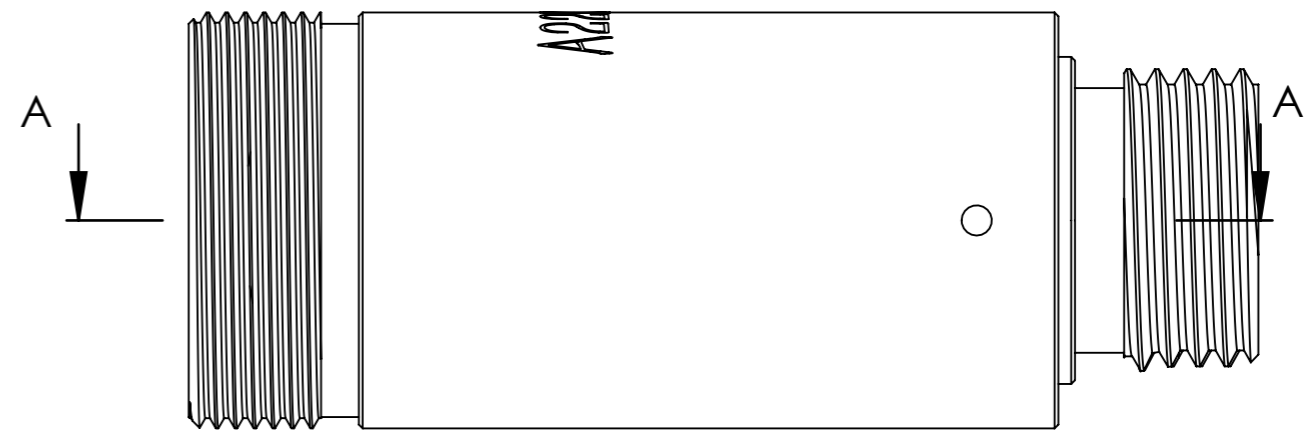
SECTION A-A

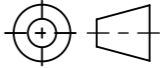

PART NUMBER	λ	ALIGNMENT FIBER	L1 (mm)	L2 ± 0.25 (mm)
FDA82020405	405nm	C405	16.34	27.63
FDA82020532	532nm	460HP	16.72	28.01
FDA82020633	633nm	SM600	16.88	28.17
FDA82020780	780nm	780HP	17.02	28.31
FDA82021064	1064nm	HI 1060	17.18	28.47
FDA82021310	1310nm	SMF-28e	17.30	28.59
FDA82021550	1550nm	SMF-28e	17.40	28.69

DO NOT SCALE DRAWING.

DRAWING PROJECTION. 

 **GH Optics (Jiangsu) Co., Ltd.**
www.ghoptics.cn

TITLE: Connectorized Collimators with FC/PC

DWG NO. **FDA82020780**

NAME	DATE
DRAWN	
CHK'D	
APPV'D	

UNIT: mm SIZE: A3 SHEET 1 OF 1 REV. A