

Photoconductive Series

Planar Diffused Silicon Photodiodes

The **Photoconductive Detector Series** are suitable for high speed and high sensitivity applications. The spectral range extends from 350 to 1100 nm, making these photodiodes ideal for visible and near IR applications, including such AC applications as detection of pulsed LASER sources, LEDs, or chopped light.

To achieve high speeds, these detectors should be reverse biased. Typical response times from 10 ns to 250 ns can be achieved with a 10V reverse bias, for example. When a reverse bias is applied, capacitance decreases (as seen in the figure below) corresponding directly to an increase in speed.

As indicated in the specification table, the reverse bias should not exceed 30 volts. Higher bias voltages will result in permanent damage to the detector.

Since a reverse bias generates additional dark current, the noise in the device will also increase with applied bias. For lower noise detectors, the Photovoltaic Series should be considered.

Refer to the Photoconductive Mode (PC) paragraph in the "Photodiode Characteristics" section of this catalog for detailed information on electronics set up.

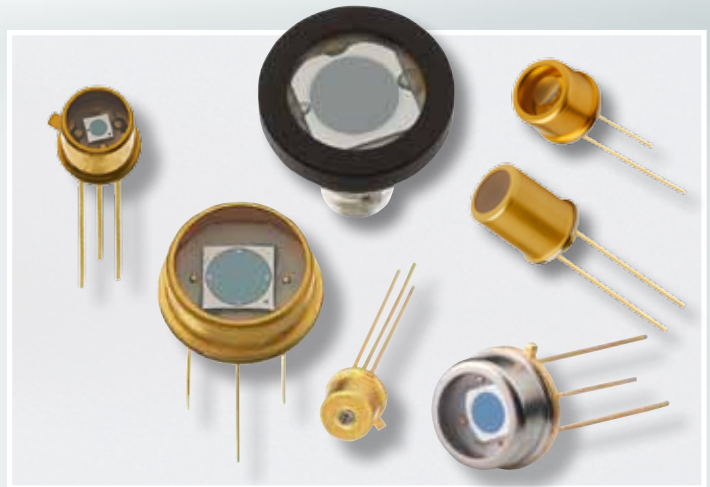

APPLICATIONS

- Pulse Detectors
- Optical Communications
- Bar Code Readers
- Optical Remote Control
- Medical Equipment
- High Speed Photometry

FEATURES

- High Speed Response
- Low Capacitance
- Low Dark Current
- Wide Dynamic Range
- High Responsivity

Typical Capacitance vs. Reverse Bias

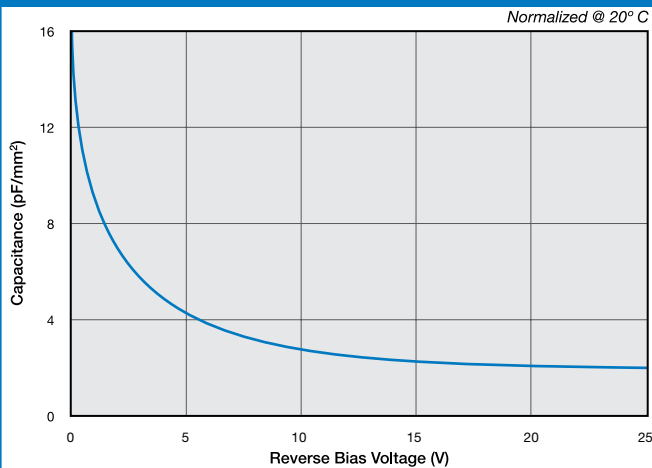

Typical Spectral Response

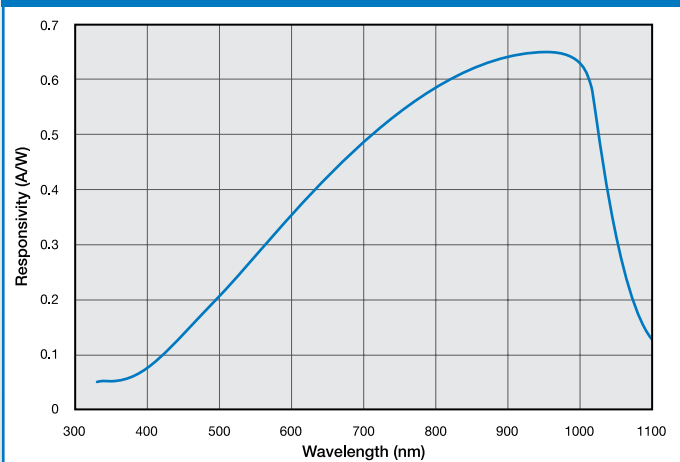

Typical Dark Current vs. Temperature

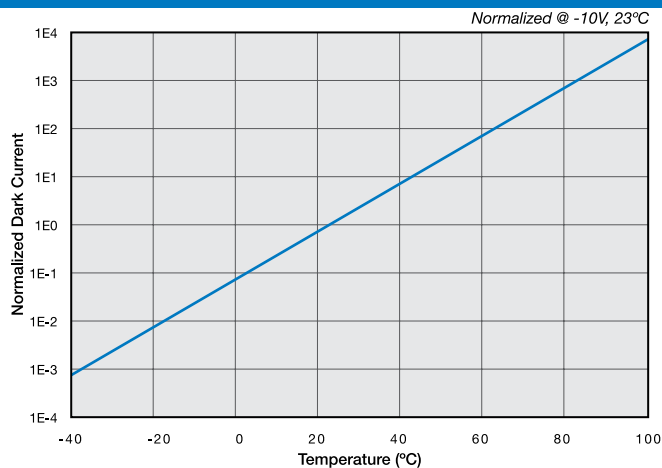

Typical Dark Current vs. Reverse Bias

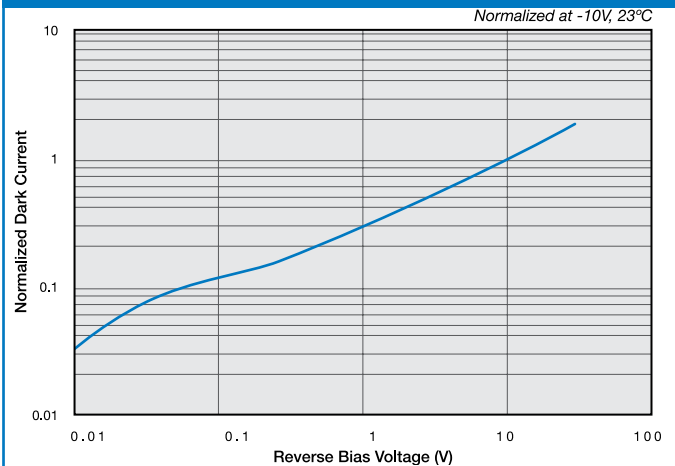

Photoconductive Series

Typical Electro-Optical Specifications at T_A=23°C

Model Number	Active Area		Peak Responsivity Wavelength	Responsivity at λ _p		Capacitance (pF)		Dark Current (nA)		NEP (W/√Hz)	Reverse Voltage (V)	Rise Time (ns)	Temp.* Range (°C)		Package Style †
	Area (mm²)	Dimensions (mm)		λ _p (nm)	(A/W)		0 V	-10 V	-10 V				-10V 970nm	-10V 632nm 50 Ω	
			typ.		min.	typ.	typ.	typ.	max.	typ.	max.	typ.			

'D' Series, Metal Package

PIN-020A	0.20	0.51 φ	970	0.60	0.65	4	1	0.01	0.15	2.8 e-15	30	6	-40 ~ +100	-55 ~ +125	1 / TO-18
PIN-040A	0.81	1.02 φ				8	2	0.05	0.50	6.2 e-15		8			4 / TO-18
PIN-2DI ‡	1.1	0.81 x 1.37				25	5	0.10	1.0	8.7 e-15		10			7 / TO-18
PIN-3CDI	3.2	1.27 x 2.54				45	12	0.15	2	1.1 e-14		12			2 / TO-5
PIN-3CD						85	15	0.25	3	1.4 e-14					5 / TO-5
PIN-5DI	5.1	2.54 φ				225	40	0.35	6	1.6 e-14		14			2 / TO-5
PIN-5D															330
PIN-13DI	13	3.6 sq				700	130	1	15	2.8 e-14		24			3 / TO-8
PIN-13D															1500
PIN-6DI	16.4	4.57 φ				9500	1800	15	1000	1.1 e-13		43			3 / TO-8
PIN-6D															17
PIN-44DI	44	6.6 sq				10	300	2	25	3.9 e-14		250			3 / TO-8
PIN-44D															24
PIN-10DI	100	11.28 φ				10	300	2	25	3.9 e-14		43			10 / Lo-Prof
PIN-10D															43
PIN-25D	613	27.9 φ	10	300	2	25	3.9 e-14	250	12 / BNC						

'O' Series, Metal Package

OSD1-0	1	1.0 sq	900	0.47	0.54	12	3	1	3	4.5 e-14	50	10	-25 ~ +75	-40 ~ +100	7 / TO-18
OSD5-0	5	2.5 φ				50	8	5	10	1.0 e-13		8			5 / TO-5
OSD15-0	15	3.8 sq				150	20	8	15	1.3 e-13		9			5 / TO-5
OSD60-0	58	7.6 sq				600	75	15	50	1.7 e-13		14			69 / TO-8
OSD100-0A	100	11.3 φ				1000	130	30	70	2.5 e-13		19			55 / Special

'D' Series, Plastic Package

PIN-220D«	200	10 x 20	970	0.60	0.65	3200	600	5	100	6.2 e-14	30	75	-10 ~ +60	20 ~ +70	27 / Plastic
------------------	-----	---------	-----	------	------	------	-----	---	-----	----------	----	----	-----------	----------	--------------

‡ The 'I' suffix on the model number is indicative of the photodiode chip being isolated from the package by an additional pin connected to the case.

† For mechanical drawings please refer to pages 61 thru 73.

* Non-condensing temperature and storage range, Non-condensing environment.

« Minimum order quantities apply

AVOID DIRECT LIGHT

Since the spectral response of silicon photodiode includes the visible light region, care must be taken to avoid photodiode exposure to high ambient light levels, particularly from tungsten sources or sunlight. During shipment from OSI Optoelectronics, your photodiodes are packaged in opaque, padded containers to avoid ambient light exposure and damage due to shock from dropping or jarring.

AVOID SHARP PHYSICAL SHOCK

Photodiodes can be rendered inoperable if dropped or sharply jarred. The wire bonds are delicate and can become separated from the photodiode's bonding pads when the detector is dropped or otherwise receives a sharp physical blow.

CLEAN WINDOWS WITH OPTICAL GRADE CLOTH / TISSUE

Most windows on OSI Optoelectronics photodiodes are either silicon or quartz. They should be cleaned with isopropyl alcohol and a soft (optical grade) pad.

OBSERVE STORAGE TEMPERATURES AND HUMIDITY LEVELS

Photodiode exposure to extreme high or low storage temperatures can affect the subsequent performance of a silicon photodiode. Storage temperature guidelines are presented in the photodiode performance specifications of this catalog. Please maintain a non-condensing environment for optimum performance and lifetime.

OBSERVE ELECTROSTATIC DISCHARGE (ESD) PRECAUTIONS

OSI Optoelectronics photodiodes, especially with IC devices (e.g. Photops) are considered ESD sensitive. The photodiodes are shipped in ESD protective packaging. When unpacking and using these products, anti-ESD precautions should be observed.

DO NOT EXPOSE PHOTODIODES TO HARSH CHEMICALS

Photodiode packages and/or operation may be impaired if exposed to CHLOROTHENE, THINNER, ACETONE, or TRICHLOROETHYLENE.

INSTALL WITH CARE

Most photodiodes in this catalog are provided with wire or pin leads for installation in circuit boards or sockets. Observe the soldering temperatures and conditions specified below:

Soldering Iron:	Soldering 30 W or less Temperature at tip of iron 300°C or lower.
Dip Soldering:	Bath Temperature: 260±5°C. Immersion Time: within 5 Sec. Soldering Time: within 3 Sec.
Vapor Phase Soldering:	DO NOT USE
Reflow Soldering:	DO NOT USE

Photodiodes in plastic packages should be given special care. Clear plastic packages are more sensitive to environmental stress than those of black plastic. Storing devices in high humidity can present problems when soldering. Since the rapid heating during soldering stresses the wire bonds and can cause wire to bonding pad separation, it is recommended that devices in plastic packages to be baked for 24 hours at 85°C.

The leads on the photodiode **SHOULD NOT BE FORMED**. If your application requires lead spacing modification, please contact OSI Optoelectronics Applications group at (310)978-0516 before forming a product's leads. Product warranties could be voided.



*Most of our standard catalog products are RoHS Compliant. Please contact us for details

Mechanical Drawings

Mechanical Specifications and Die Topography

1. Parameter Definitions:

A = Distance from top of chip to top of glass.

a = Photodiode Anode.

B = Distance from top of glass to bottom of case.

c = Photodiode Cathode

(Note: cathode is common to case in metal package products unless otherwise noted).

W = Window Diameter.

F.O.V. = Filed of View (see definition below).

2. Dimensions are in inches (1 inch = 25.4 mm).

3. Pin diameters are 0.018 ± 0.002 " unless otherwise specified.

4. Tolerances (unless otherwise noted)

General: $0.XX \pm 0.01$ "

$0.XXX \pm 0.005$ "

Chip Centering: ± 0.010 "

Dimension 'A': ± 0.015 "

5. Windows

All '**UV**' Enhanced products are provided with QUARTZ glass windows, 0.027 ± 0.002 " thick.

All '**XUV**' products are provided with removable windows.

All '**DLS**' PSD products are provided with A/R coated glass windows.

All '**FIL**' photoconductive and photovoltaic products are epoxy filled instead of glass windows.

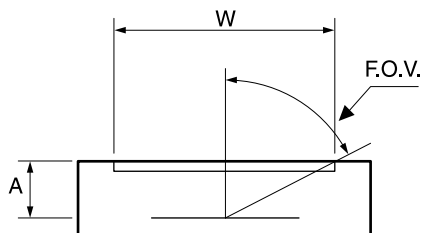

$$F.O.V. = \tan^{-1} \left(\frac{W}{2A} \right)$$

For Further Assistance
Please Call One of Our Experienced
Sales and Applications Engineers

310-978-0516

OSI Optoelectronics
An OSI Systems Company

- Or -

visit our website at

www.osioptoelectronics.com

Mechanical Specifications

All units in inches. Pinouts are bottom view.

1 TO-18	2 TO-5	3 TO-8																															
<p>Products: PIN-020A PIN-040A PIN-040-DP/SB</p> <p>Pin Circle Dia.=0.100</p> <table border="1"> <thead> <tr> <th>P/N</th> <th>A</th> <th>B</th> <th>W</th> </tr> </thead> <tbody> <tr> <td>PIN-020A</td> <td>0.075</td> <td>0.200</td> <td>0.155</td> </tr> <tr> <td>PIN-040A</td> <td>0.075</td> <td>0.200</td> <td>0.155</td> </tr> </tbody> </table>	P/N	A	B	W	PIN-020A	0.075	0.200	0.155	PIN-040A	0.075	0.200	0.155	<p>Products: PIN-5DI PIN-5DPI PIN-13DI PIN-13DPI PIN-5-YAG CD-25T</p> <p>Pin Circle Dia.=0.200</p> <table border="1"> <thead> <tr> <th>P/N</th> <th>A</th> <th>B</th> <th>W</th> </tr> </thead> <tbody> <tr> <td>All Others</td> <td>0.094</td> <td>0.180</td> <td>0.240</td> </tr> <tr> <td>CD-25T</td> <td>0.050</td> <td>0.130</td> <td>0.23</td> </tr> </tbody> </table>	P/N	A	B	W	All Others	0.094	0.180	0.240	CD-25T	0.050	0.130	0.23	<p>Products: PIN-6DI PIN-6DPI PIN-44DI PIN-44DPI</p> <p>APD50-8-150-TO8</p> <p>Pin Circle Dia.=0.295</p> <table border="1"> <thead> <tr> <th>P/N</th> <th>A</th> </tr> </thead> <tbody> <tr> <td>PIN-6DI/6DPI APD50-8-150-TO8</td> <td>0.115</td> </tr> <tr> <td>PIN-44DI/44DPI</td> <td>0.125</td> </tr> </tbody> </table>	P/N	A	PIN-6DI/6DPI APD50-8-150-TO8	0.115	PIN-44DI/44DPI	0.125	
P/N	A	B	W																														
PIN-020A	0.075	0.200	0.155																														
PIN-040A	0.075	0.200	0.155																														
P/N	A	B	W																														
All Others	0.094	0.180	0.240																														
CD-25T	0.050	0.130	0.23																														
P/N	A																																
PIN-6DI/6DPI APD50-8-150-TO8	0.115																																
PIN-44DI/44DPI	0.125																																
<p>Products: PIN-2DI PIN-2DPI PIN-3CDI PIN-3CDPI</p> <p>Pin Circle Dia.=0.100</p> <table border="1"> <thead> <tr> <th>A</th> <th>B</th> </tr> </thead> <tbody> <tr> <td>0.090</td> <td>0.150</td> </tr> </tbody> </table>	A	B	0.090	0.150	<p>Products: PIN-5D PIN-5DP PIN-5DP/SB PIN-13D PIN-13DP PIN-005E-550F</p> <p>OSD-5-0 OSD15-0 OSD5-5T OSD15-5T</p> <p>UV-001 UV-005 UV-005DQ UV-005EQ UV-013DQ UV-013EQ UV-015</p> <p>Pin Circle Dia.=0.200</p> <table border="1"> <thead> <tr> <th>P/N</th> <th>A</th> <th>B</th> </tr> </thead> <tbody> <tr> <td>OSD-Prefix Devices</td> <td>0.050</td> <td>0.130</td> </tr> <tr> <td>UV-XXXDQ</td> <td>0.065</td> <td>0.138</td> </tr> <tr> <td>UV-XXXEQ</td> <td>0.055</td> <td>0.138</td> </tr> <tr> <td>All Others</td> <td>0.102</td> <td>0.180</td> </tr> </tbody> </table> <p>Quartz Window: OSD5.8-7Q UV Transmissive Window: OSD5.8-7U</p>	P/N	A	B	OSD-Prefix Devices	0.050	0.130	UV-XXXDQ	0.065	0.138	UV-XXXEQ	0.055	0.138	All Others	0.102	0.180	<p>Products: PIN-6D PIN-6DP PIN-44D PIN-44DP UV-020 UV-035DQ UV-035EQ UV-035</p> <p>Dimensions</p> <table border="1"> <thead> <tr> <th>P/N</th> <th>A</th> <th>B</th> </tr> </thead> <tbody> <tr> <td>UV-035DQ</td> <td>0.130</td> <td>0.195</td> </tr> <tr> <td>UV-035EQ</td> <td>0.120</td> <td>0.195</td> </tr> <tr> <td>All Others</td> <td>0.140</td> <td>0.205</td> </tr> </tbody> </table>	P/N	A	B	UV-035DQ	0.130	0.195	UV-035EQ	0.120	0.195	All Others	0.140	0.205
A	B																																
0.090	0.150																																
P/N	A	B																															
OSD-Prefix Devices	0.050	0.130																															
UV-XXXDQ	0.065	0.138																															
UV-XXXEQ	0.055	0.138																															
All Others	0.102	0.180																															
P/N	A	B																															
UV-035DQ	0.130	0.195																															
UV-035EQ	0.120	0.195																															
All Others	0.140	0.205																															
<p>Products: PIN-3CD PIN-3CDP BPX-65 OSD1-0 OSD1-5T OSD3-5T OSD1-E OSD3-E</p> <p>Pin Circle Dia.=0.100</p> <table border="1"> <thead> <tr> <th>P/N</th> <th>A</th> <th>B</th> </tr> </thead> <tbody> <tr> <td>PIN-3CD / 3CDP</td> <td>0.087</td> <td>0.146</td> </tr> <tr> <td>BPX-65</td> <td>0.075</td> <td>0.200</td> </tr> <tr> <td>OSD-Prefix Devices</td> <td>0.080</td> <td>0.200</td> </tr> </tbody> </table> <p>Quartz Window: OSD1.2-7Q UV Transmissive Window: OSD1.2-7U</p>	P/N	A	B	PIN-3CD / 3CDP	0.087	0.146	BPX-65	0.075	0.200	OSD-Prefix Devices	0.080	0.200	<p>Products: PIN-125DPL</p> <p>Pin Circle Dia.=0.100</p>	<p>Products: PIN-HR005 PIN-HR008 PIN-HR020 PIN-HR026 PIN-HR040</p> <p>Pin Circle Dia.=0.100</p>																			
P/N	A	B																															
PIN-3CD / 3CDP	0.087	0.146																															
BPX-65	0.075	0.200																															
OSD-Prefix Devices	0.080	0.200																															

Mechanical Specifications

All units in inches. Pinouts are bottom view.

10 Low Profile

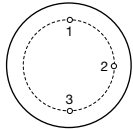
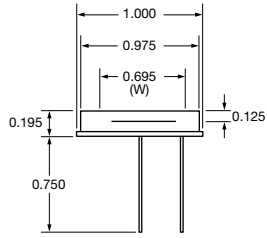

Pin Circle Dia.=0.73

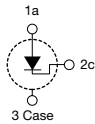

Products:

PIN-10DI
PIN-10DPI
PIN-10DPI/SB
UV-50L
UV-100L

11 BNC

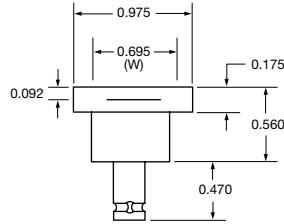

Outer Contact — Anode	PIN-10D, PIN-10DP, PIN-10DP/SB UV-100DQ, UV-100EQ
Outer Contact — Cathode	UV-50, UV-100

Products:

PIN-10D
PIN-10DP
PIN-10DP/SB
UV-50
UV-100
UV-100DQ
UV-100EQ

12 BNC

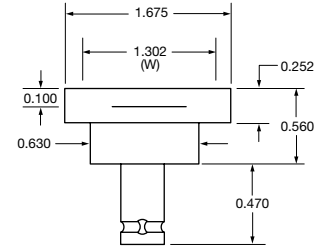

Outer Contact — Anode

Products:

PIN-25D
PIN-25DP

13 Special BNC

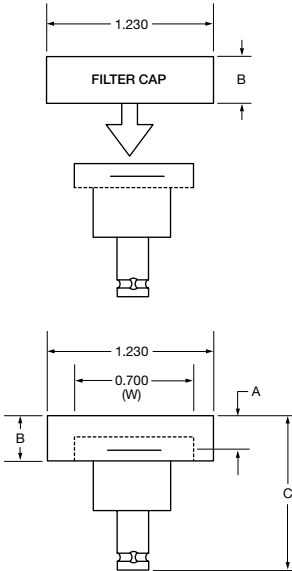

Dimensions			
P/N	A	B	C
PIN-10DF	0.217	0.330	1.020
PIN-10AP	0.386	0.550	1.415

Products:

PIN-10AP
PIN-10DF

14 TO-5

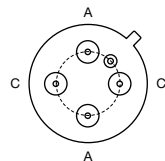
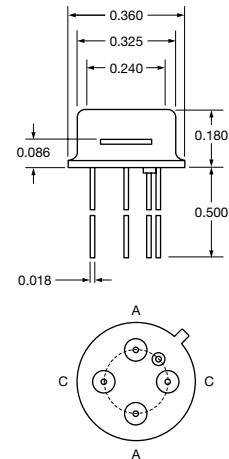

Pin Circle Dia.= 0.200
Bottom View

Products:

DLS-2S

15 Special Plastic

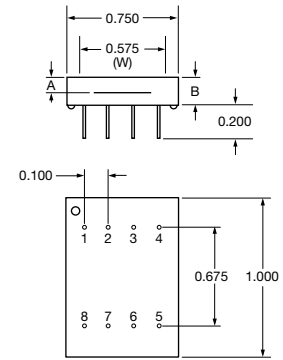

Dimensions

P/N	A	B
FIL-UV50	0.090	0.155

Pinouts

P/N	1	2	3	4	5	6	7	8
FIL-UV50	c	-	-	a	c	-	-	a

Mechanical Specifications

All units in inches. Pinouts are bottom view.

22 TO-5

Products:

XUV-005

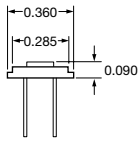

Pin Circle Dia.=0.200



23 TO-8

Products:

XUV-020
XUV-035

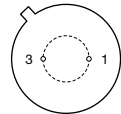
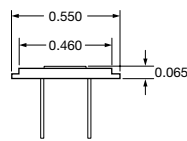

Pin Circle Dia.=0.295



24 TO-8

Products:

PIN-DSIn-TEC

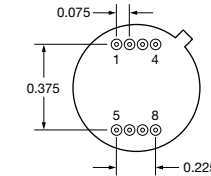
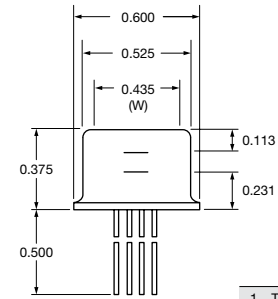

Pinout

- | | |
|---|------------------------|
| 1 | TEC (-) |
| 2 | Thermistor |
| 3 | Thermistor |
| 4 | TEC (+) |
| 5 | Top Silicon, Cathode |
| 6 | Top Silicon, Anode |
| 7 | Bottom InGaAs, Anode |
| 8 | Bottom InGaAs, Cathode |

25 Special Ceramic / Plastic

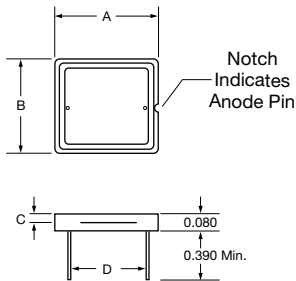

Notch Indicates Anode Pin

Dimensions

P/N	A	B	C	D
UV-005EQC	0.300	0.236	0.024	0.177
UV-035EQC	0.400	0.350	0.028	0.290
UV-100EQC	0.650	0.590	0.028	0.490
UV-005DQC	0.300	0.236	0.035	0.177
UV-035DQC	0.400	0.350	0.039	0.290
UV-100DQC	0.650	0.590	0.039	0.490
XUV-50C	0.650	0.590	0.027	0.490
XUV-100C	0.650	0.590	0.027	0.490
RD-100	0.650	0.590	0.027	0.490
RD-100A	0.650	0.590	0.027	0.490
UV-35P	0.390	0.345	0.050	0.275
OSD35-LR-A	0.390	0.350	---	0.290
OSD35-LR-D	0.390	0.350	---	0.290

Note: OSD35-prefix packages come with 0.31" (min.) leads

26 TO-8

Products:

RD-100
RD-100A
UV-35P
UV-005EQC
UV-035EQC
UV-100EQC
UV-005DQC
UV-035DQC
UV-100DQC
XUV-50C
XUV-100C
OSD35-LR-A
OSD35-LR-D

Products:

PIN-RD07
PIN-RD15

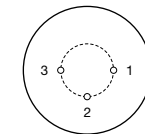
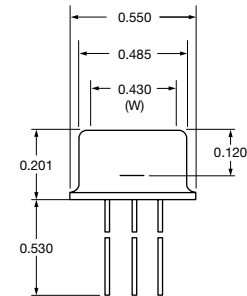

Pin Circle Dia.=0.295

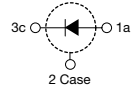

27 Special Plastic

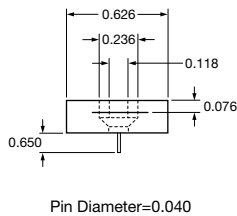
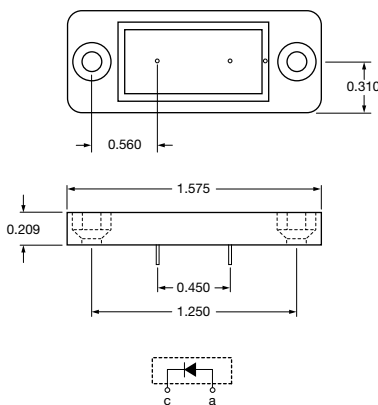

Pin Diameter=0.040



28 BNC

Products:

PIN-220D
PIN-220DP
PIN-220DP/SB

Products:

XUV-100

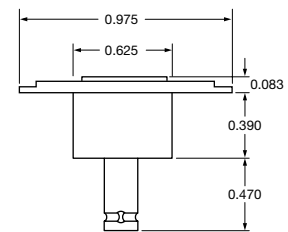

BNC Connector
Outer Contact = Cathode

Mechanical Specifications

All units in inches. Pinouts are bottom view.

51 Low Cost Ceramic	52 Special	53 Special														
<p>Products: SL-30</p>	<p>Products: A2V-76</p> <p>Pin Diameter = 0.025</p>	<p>Products: A2V-16</p> <table border="1"> <caption>Dimensions</caption> <thead> <tr> <th>P/N</th> <th>A</th> <th>B</th> <th>C</th> <th>D</th> <th>E</th> <th>F</th> </tr> </thead> <tbody> <tr> <td>A2V-16</td> <td>1</td> <td>0.1</td> <td>0.212</td> <td>0.2</td> <td>0.062</td> <td>0.06</td> </tr> </tbody> </table>	P/N	A	B	C	D	E	F	A2V-16	1	0.1	0.212	0.2	0.062	0.06
P/N	A	B	C	D	E	F										
A2V-16	1	0.1	0.212	0.2	0.062	0.06										

54 40-PIN-DIP	55 Special																																																																																																																																																																								
<p>Products: A5V-35UV A5C-35, A5C-38 A5V-35, A5V-38</p> <table border="1"> <caption>35 Element Array</caption> <thead> <tr> <th>Pin Number</th> <th>Element Number</th> <th>Pin Number</th> <th>Element Number</th> </tr> </thead> <tbody> <tr><td>1</td><td>C</td><td>21</td><td>C</td></tr> <tr><td>2</td><td>2</td><td>22</td><td>35</td></tr> <tr><td>3</td><td>4</td><td>23</td><td>33</td></tr> <tr><td>4</td><td>6</td><td>24</td><td>31</td></tr> <tr><td>5</td><td>8</td><td>25</td><td>29</td></tr> <tr><td>6</td><td>10</td><td>26</td><td>27</td></tr> <tr><td>7</td><td>12</td><td>27</td><td>25</td></tr> <tr><td>8</td><td>14</td><td>28</td><td>23</td></tr> <tr><td>9</td><td>16</td><td>29</td><td>21</td></tr> <tr><td>10</td><td>18</td><td>30</td><td>19</td></tr> <tr><td>11</td><td>--</td><td>31</td><td>17</td></tr> <tr><td>12</td><td>20</td><td>32</td><td>15</td></tr> <tr><td>13</td><td>22</td><td>33</td><td>13</td></tr> <tr><td>14</td><td>24</td><td>34</td><td>11</td></tr> <tr><td>15</td><td>26</td><td>35</td><td>9</td></tr> <tr><td>16</td><td>28</td><td>36</td><td>7</td></tr> <tr><td>17</td><td>30</td><td>37</td><td>5</td></tr> <tr><td>18</td><td>32</td><td>38</td><td>3</td></tr> <tr><td>19</td><td>34</td><td>39</td><td>1</td></tr> <tr><td>20</td><td>C</td><td>40</td><td>C</td></tr> </tbody> </table> <table border="1"> <caption>38 Element Array</caption> <thead> <tr> <th>Pin Number</th> <th>Element Number</th> <th>Pin Number</th> <th>Element Number</th> </tr> </thead> <tbody> <tr><td>1</td><td>C</td><td>21</td><td>C</td></tr> <tr><td>2</td><td>2</td><td>22</td><td>37</td></tr> <tr><td>3</td><td>4</td><td>23</td><td>35</td></tr> <tr><td>4</td><td>6</td><td>24</td><td>33</td></tr> <tr><td>5</td><td>8</td><td>25</td><td>31</td></tr> <tr><td>6</td><td>10</td><td>26</td><td>29</td></tr> <tr><td>7</td><td>12</td><td>27</td><td>27</td></tr> <tr><td>8</td><td>14</td><td>28</td><td>25</td></tr> <tr><td>9</td><td>16</td><td>29</td><td>23</td></tr> <tr><td>10</td><td>18</td><td>30</td><td>21</td></tr> <tr><td>11</td><td>20</td><td>31</td><td>19</td></tr> <tr><td>12</td><td>22</td><td>32</td><td>17</td></tr> <tr><td>13</td><td>24</td><td>33</td><td>15</td></tr> <tr><td>14</td><td>26</td><td>34</td><td>13</td></tr> <tr><td>15</td><td>28</td><td>35</td><td>11</td></tr> <tr><td>16</td><td>30</td><td>36</td><td>9</td></tr> <tr><td>17</td><td>32</td><td>37</td><td>7</td></tr> <tr><td>18</td><td>34</td><td>38</td><td>5</td></tr> <tr><td>19</td><td>36</td><td>39</td><td>3</td></tr> <tr><td>20</td><td>38</td><td>40</td><td>1</td></tr> </tbody> </table>	Pin Number	Element Number	Pin Number	Element Number	1	C	21	C	2	2	22	35	3	4	23	33	4	6	24	31	5	8	25	29	6	10	26	27	7	12	27	25	8	14	28	23	9	16	29	21	10	18	30	19	11	--	31	17	12	20	32	15	13	22	33	13	14	24	34	11	15	26	35	9	16	28	36	7	17	30	37	5	18	32	38	3	19	34	39	1	20	C	40	C	Pin Number	Element Number	Pin Number	Element Number	1	C	21	C	2	2	22	37	3	4	23	35	4	6	24	33	5	8	25	31	6	10	26	29	7	12	27	27	8	14	28	25	9	16	29	23	10	18	30	21	11	20	31	19	12	22	32	17	13	24	33	15	14	26	34	13	15	28	35	11	16	30	36	9	17	32	37	7	18	34	38	5	19	36	39	3	20	38	40	1	<p>Products: OSD100-0A OSD100-5TA</p> <p>RED DOT INDICATES CATHODE LEAD</p>
Pin Number	Element Number	Pin Number	Element Number																																																																																																																																																																						
1	C	21	C																																																																																																																																																																						
2	2	22	35																																																																																																																																																																						
3	4	23	33																																																																																																																																																																						
4	6	24	31																																																																																																																																																																						
5	8	25	29																																																																																																																																																																						
6	10	26	27																																																																																																																																																																						
7	12	27	25																																																																																																																																																																						
8	14	28	23																																																																																																																																																																						
9	16	29	21																																																																																																																																																																						
10	18	30	19																																																																																																																																																																						
11	--	31	17																																																																																																																																																																						
12	20	32	15																																																																																																																																																																						
13	22	33	13																																																																																																																																																																						
14	24	34	11																																																																																																																																																																						
15	26	35	9																																																																																																																																																																						
16	28	36	7																																																																																																																																																																						
17	30	37	5																																																																																																																																																																						
18	32	38	3																																																																																																																																																																						
19	34	39	1																																																																																																																																																																						
20	C	40	C																																																																																																																																																																						
Pin Number	Element Number	Pin Number	Element Number																																																																																																																																																																						
1	C	21	C																																																																																																																																																																						
2	2	22	37																																																																																																																																																																						
3	4	23	35																																																																																																																																																																						
4	6	24	33																																																																																																																																																																						
5	8	25	31																																																																																																																																																																						
6	10	26	29																																																																																																																																																																						
7	12	27	27																																																																																																																																																																						
8	14	28	25																																																																																																																																																																						
9	16	29	23																																																																																																																																																																						
10	18	30	21																																																																																																																																																																						
11	20	31	19																																																																																																																																																																						
12	22	32	17																																																																																																																																																																						
13	24	33	15																																																																																																																																																																						
14	26	34	13																																																																																																																																																																						
15	28	35	11																																																																																																																																																																						
16	30	36	9																																																																																																																																																																						
17	32	37	7																																																																																																																																																																						
18	34	38	5																																																																																																																																																																						
19	36	39	3																																																																																																																																																																						
20	38	40	1																																																																																																																																																																						

Mechanical Specifications

All units in inches. Pinouts are bottom view.

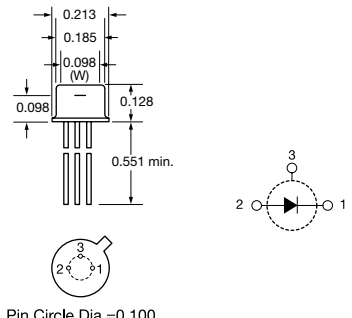
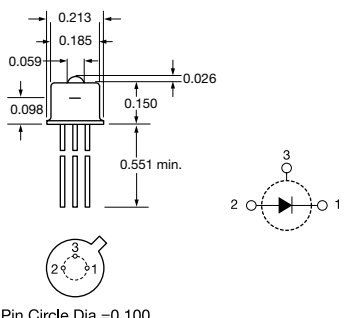
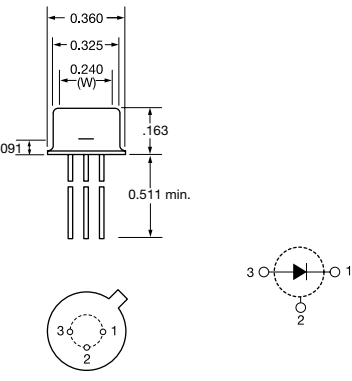
65 TO-52	66 TO-52L	67 TO-5
<p>Products: APD02-8-150-T52 APD05-8-150-T52 APD10-8-150-T52</p>  <p>Pin Circle Dia.=0.100</p>	<p>Products: APD02-8-150-T52L APD05-8-150-T52L APD10-8-150-T52L</p>  <p>Pin Circle Dia.=0.100</p>	<p>Products: APD15-8-150-TO5 APD30-8-150-TO5</p>  <p>Pin Circle Dia.=0.200</p>

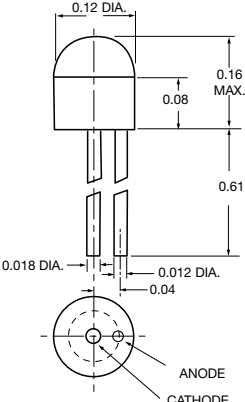
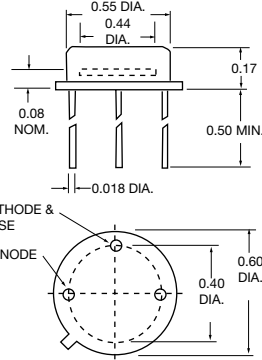
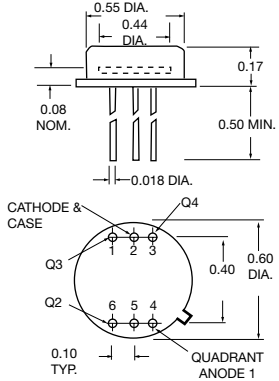
68 Plastic	69 TO-8	70 TO-8
<p>Products: CD-1705</p>  <p>ANODE CATHODE</p>	<p>Products: OSD60-0 OSD60-ST OSD60-E</p>  <p>CATHODE & CASE ANODE</p>	<p>Products: QD50-0</p>  <p>CATHODE & CASE Q4 Q3 Q2 Q1 QUADRANT ANODE 1</p>