

Distributor

 info@amstechnologies.com
 www.amstechnologies-webshop.com
Contact us

ITEM	Material	DESCRIPTION
1 3420003	SUS 304L	SMA CONNECTORS
2 3420012	SUS 304L	HOUSING
3 LE4560	D-ZLAF52LAM	MOLDED ASPHERE

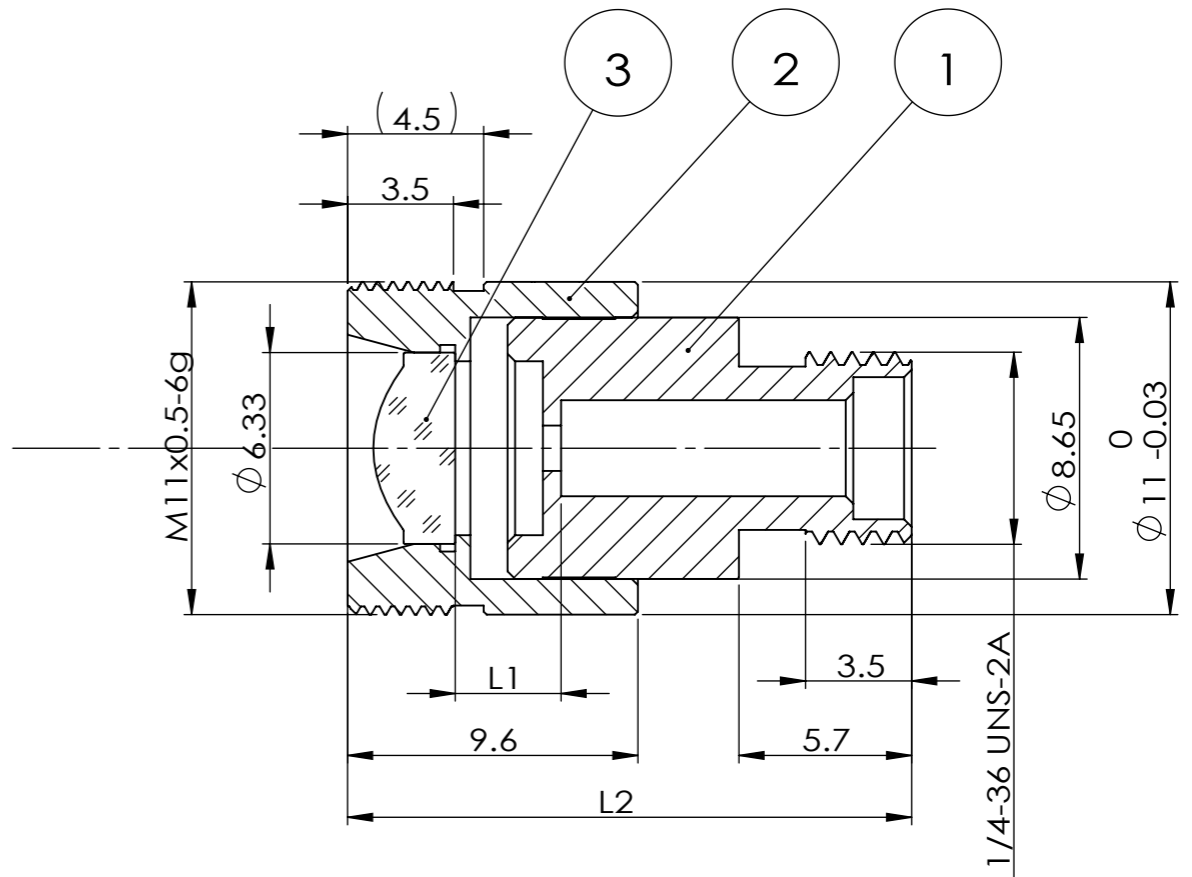

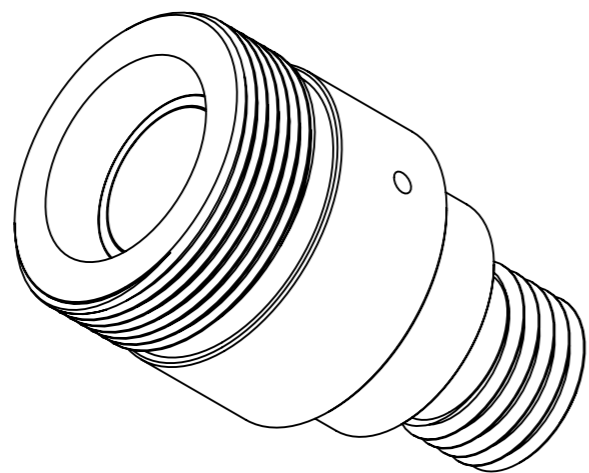

SECTION A-A

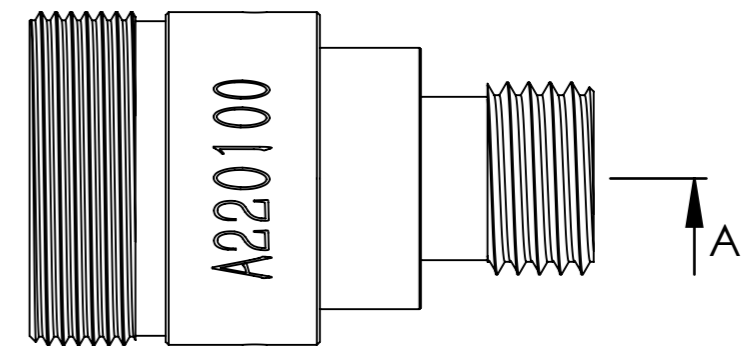
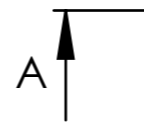
PART NUMBER	λ	ALIGNMENT FIBER	L1 (mm)	L2 ± 0.25 (mm)
FE456030405	405nm	C405	2.78	18.35
FE456030532	532nm	460HP	2.91	18.48
FE456030633	633nm	SM600	2.96	18.53
FE456030780	780nm	780HP	3.00	18.57
FE456031064	1064nm	HI-1060	3.04	18.61
FE456031310	1310nm	SMF-28e	3.06	18.63
FE456031550	1550nm	SMF-28e	3.08	18.65

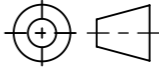

DO NOT SCALE DRAWING.

DRAWING PROJECTION. 

 **GH Optics (Jiangsu) Co., Ltd.**
www.ghoptics.cn

TITLE: Connectorized Collimators with SMA

DWG NO. FE456030405

NAME	DATE
DRAWN	
CHK'D	
APPV'D	

UNIT: mm SIZE: A3 SHEET 1 OF 1 REV. A