

Distributor

 info@amstechnologies.com
 www.amstechnologies-webshop.com
Contact us

ITEM	Material	DESCRIPTION
1	LE6240	D-ZLAF52LAM
2	3420011	SUS 304L
3	3420002	SUS 304L

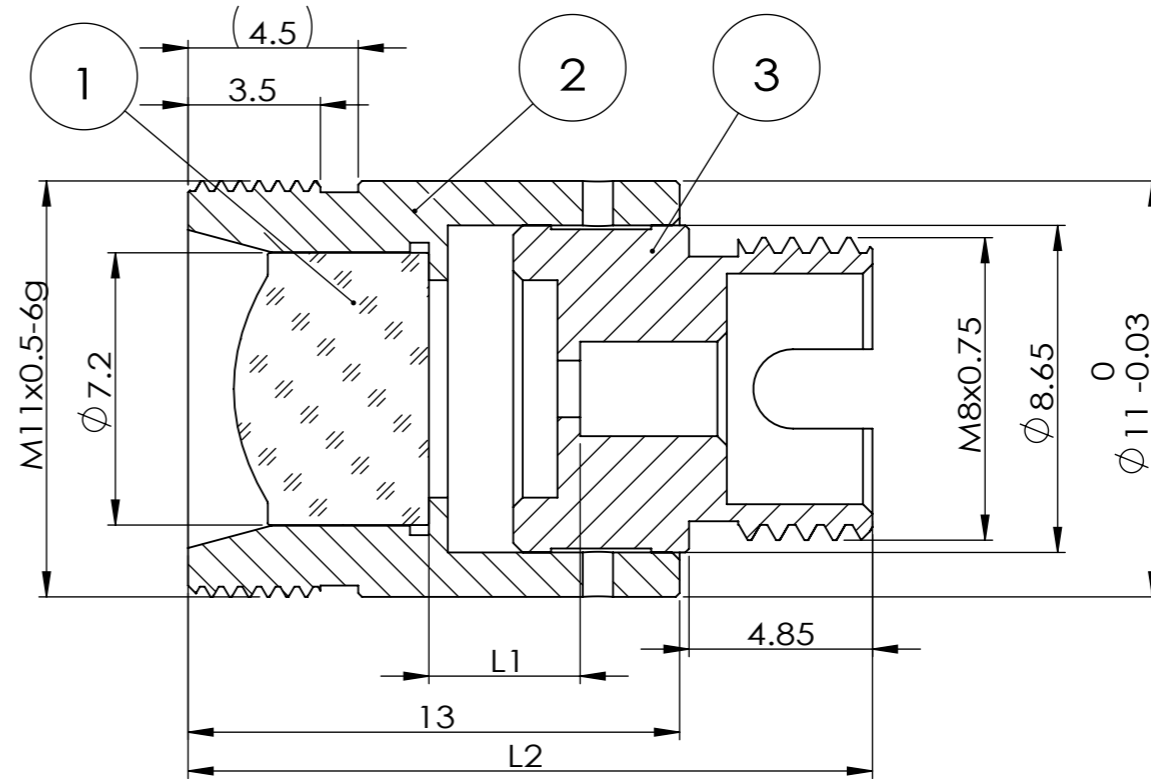
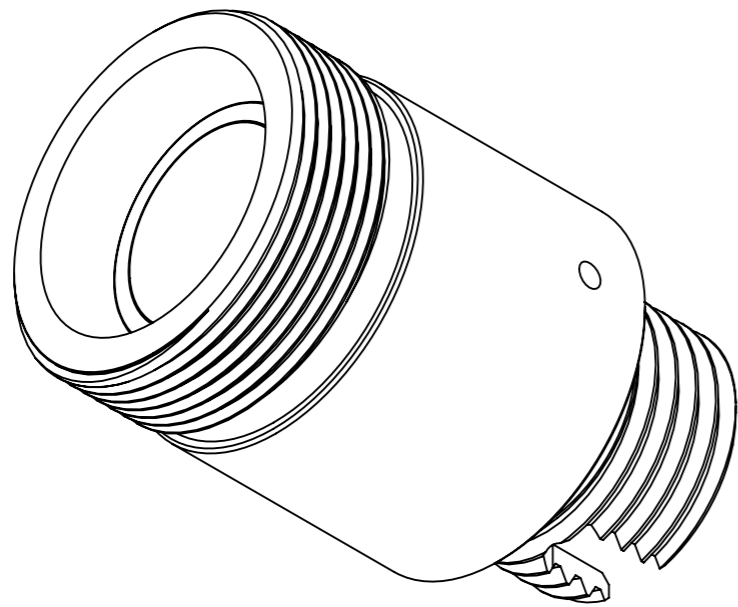

SECTION A-A

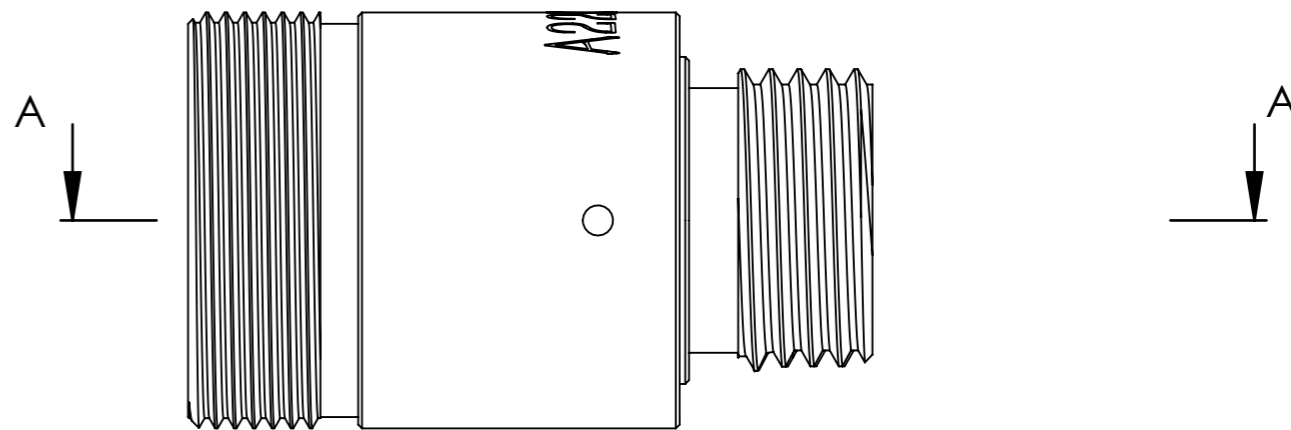

PART NUMBER	λ	ALIGNMENT FIBER	L1 (mm)	L2 ± 0.25 (mm)
FE624020405	405nm	C405	3.08	17.18
FE624020532	532nm	460HP	3.24	17.34
FE624020633	633nm	SM600	3.31	17.41
FE624020780	780nm	780HP	3.36	17.46
FE624021064	1064nm	HI 1060	3.42	17.52
FE624021310	1310nm	SMF-28e	3.45	17.55
FE624021550	1550nm	SMF-28e	3.48	17.58

DO NOT SCALE DRAWING.

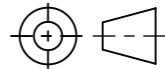
DRAWING PROJECTION. 

GH Optics (Jiangsu) Co., Ltd.
 www.ghoptics.cn

GHOPTICS
 光皓光学

TITLE:
 Connectorized Collimators with FC/PC

DWG NO.
FE624020532

NAME	DATE
DRAWN	
CHK'D	
APPV'D	

UNIT: mm SIZE: A3 SHEET 1 OF 1 REV. A