

Filterlüfter **LV 500**

Filter Fan

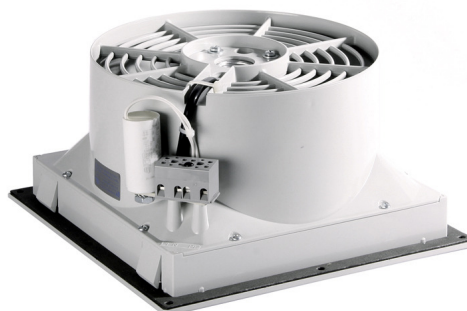

Technische Daten / Technical data:					
Type:	LV 500				
Spannung Voltage	230 V 50/60 Hz		115 V 50/60 Hz		400 V 3~ (*) 50/60 Hz
Förderrichtung Air flow	blasend blowing	saugend sucking	blasend blowing	saugend sucking	blasend blowing
Stromaufnahme Amperage	0,27/0,32 A	0,34 A	0,65 A	0,60/0,73 A	0,17/0,13 A
Leistung Power input	50/74 W	64/83 W	82 W	65/85 W	68/70 W
Drehzahl Speed	2740/3100 min ⁻¹	2600/2900 min ⁻¹	3050 min ⁻¹	2500/2700 min ⁻¹	2600/2900 min ⁻¹
Temperaturbereich Temperature range	-10...+55°C				
Lebensdauer Service life	40.000 h				
Schallpegel Noise level	65 dB (A)				
Zulassung Approval	UL (IP 54), CE				CE
Farben colours	RAL 7035 (Standard), RAL 7032				
Schutzart Degree of protection	IP 54 mit Filtermatte G3 IP 54 with Filter mat G3				
	IP 55 mit Z-Line Filter (F5) und Streckmetall, UV-beständiges Frontgitter IP 55 with Z-Line Filter (F5) and expanded metal, UV-resistant front grille				
Luftfördermenge / Air flow: (m³/h)					
Filtermatte Filter mat	P15/350S		P15/500S		P15/350S + T3/290S
Luftleistung freiblasend Air flow free air	315		260		165
mit Austrittsfilter GV 400 with exhaust filter	235		195		145

Saugende Ausführung separat bestellen!
Suction version to be ordered separately!

Zubehör / **Accessories:**

Austrittsfilter / Exhaust filter
Dichtung / gasket (enthalten / included)
Ersatzfiltermatte / Replacement filter mat
Thermostate / Thermostats

GV 400/500
D 400
AM 435P, AM 400P, AM 400T, ZF 400/500
TRS 60, TRW 60, TWR 60, TKW 60

(*)
Bei 3 ~ Ausführung muss als Vorsicherung ein Motorschutzschalter verwendet werden. Der Einstellwert darf max. 10% über dem Nennstrom des Lüfters liegen.

A motor circuit switch is necessary for protection of the 3 ~ version. The adjustment may not be higher than 10% above the nominal current of the fan.

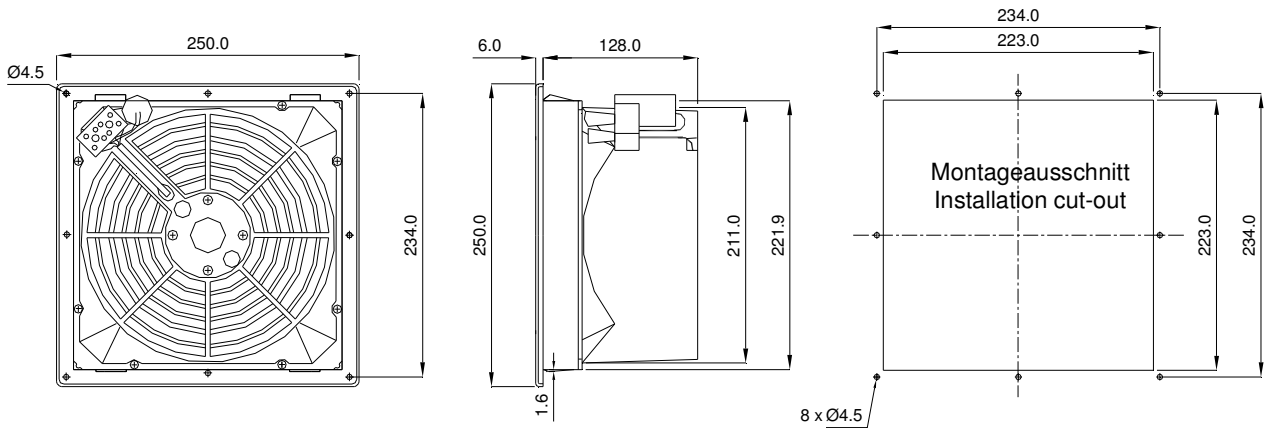

Bohrungen nur bei Schraubbefestigung

Drill-holes are only necessary if fan is to be fastened with screws

Leistungsdiagramm
Performance diagram

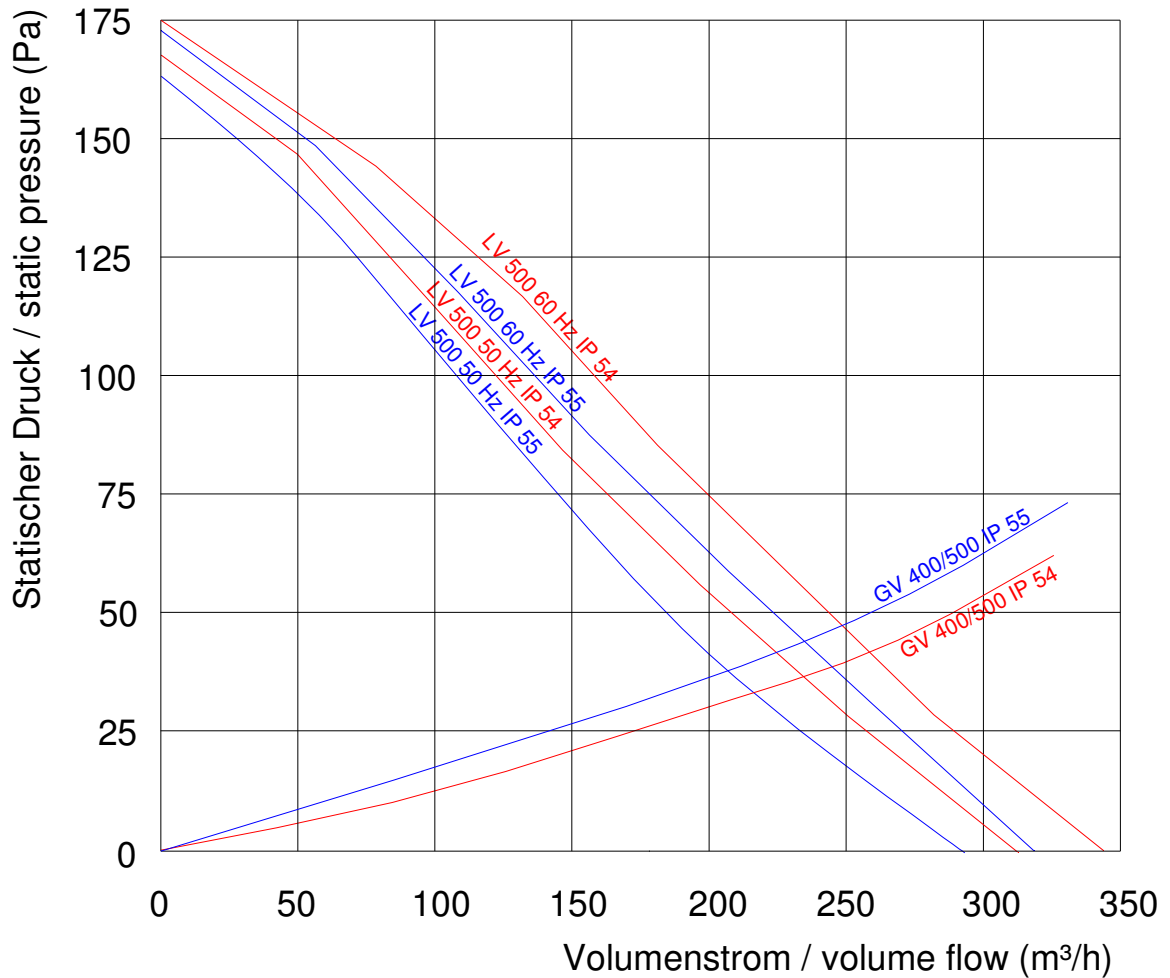

Rev. 03/12

