

Distributor

 info@amstechnologies.com
 www.amstechnologies-webshop.com
Contact us 

ITEM	Material	DESCRIPTION
1	LDA130	D-ZK3M MOLDED ASPHERE
2	3420015	SUS 304L HOUSING
3	3420002	SUS 304L FC/PC CONNECTORS

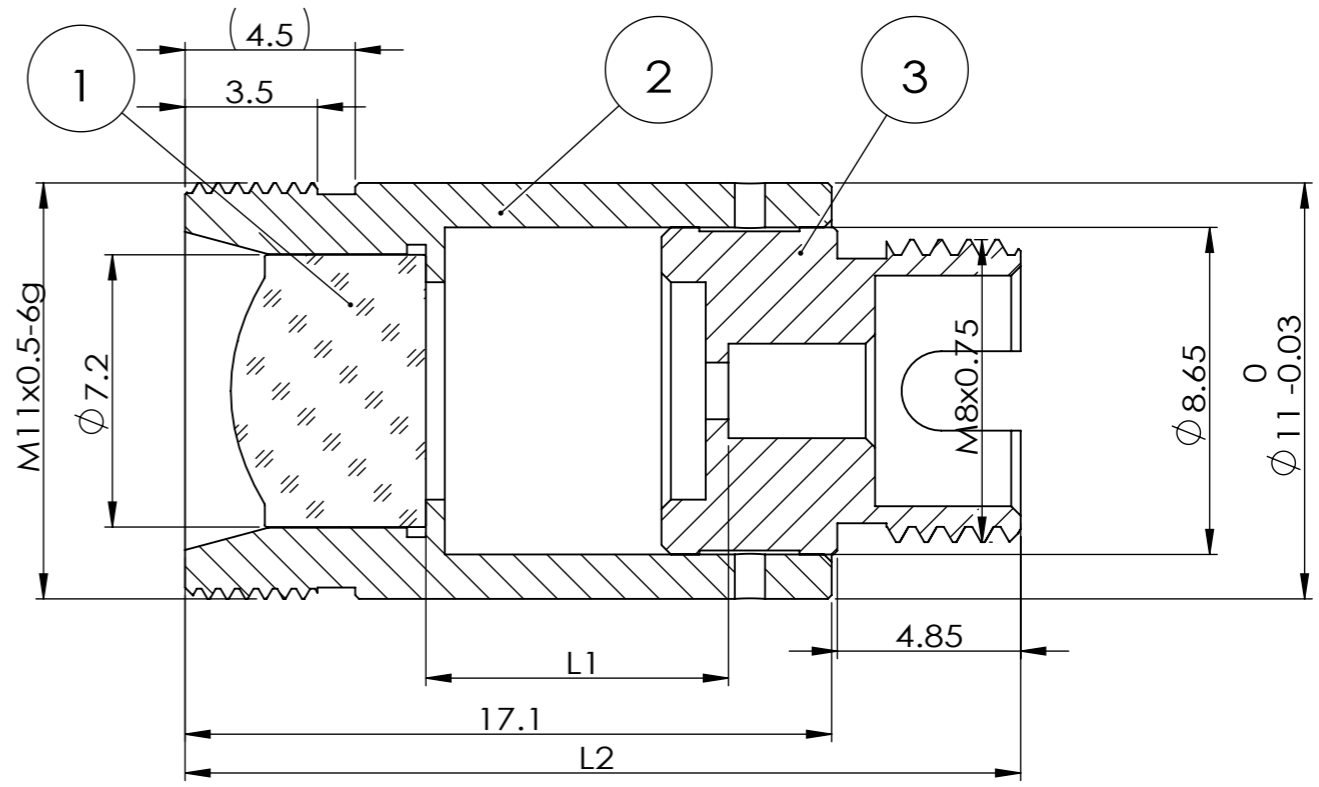

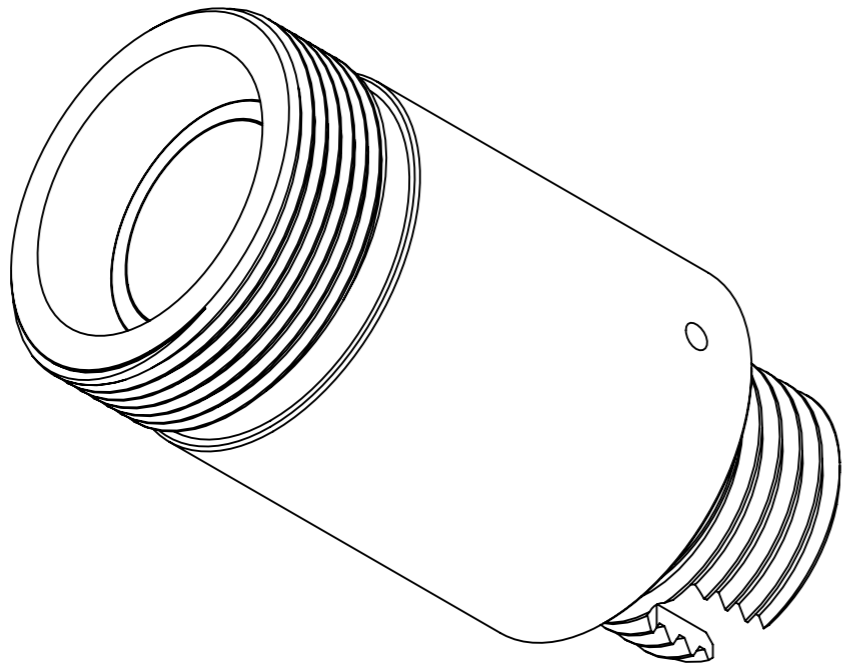

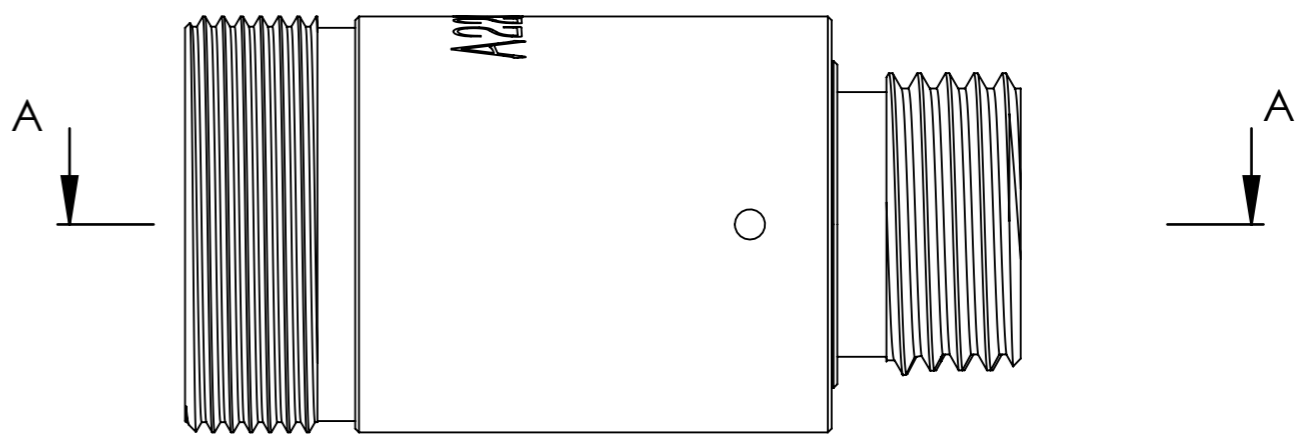
SECTION A-A

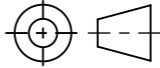

PART NUMBER	λ	ALIGNMENT FIBER	L1 (mm)	L2 ± 0.25 (mm)
FDA13020405	405nm	C405	7.53	21.73
FDA13020532	532nm	460HP	7.74	21.94
FDA13020633	633nm	SM600	7.82	22.02
FDA13020780	780nm	780HP	7.90	22.10
FDA13021064	1064nm	HI 1060	7.99	22.19
FDA13021310	1310nm	SMF-28e	8.05	22.25
FDA13021550	1550nm	SMF-28e	8.11	22.31

DO NOT SCALE DRAWING.

DRAWING PROJECTION. 

 **GH Optics (Jiangsu) Co., Ltd.**
www.ghoptics.cn

TITLE: Connectorized Collimators with FC/PC

DWG NO. **FDA13021550**

NAME	DATE
DRAWN	
CHK'D	
APPV'D	

UNIT: mm SIZE: A3 SHEET 1 OF 1 REV. A