

# EYP-RWE-0655-00505-2000-SOT02-0000

Revision 1.00

## GAIN CHIPS AR coated Fabry-Perot Laser

Distributor

where technologies meet solutions

[info@amstechnologies.com](mailto:info@amstechnologies.com)  
[www.amstechnologies-webshop.com](http://www.amstechnologies-webshop.com)

**Contact us**

### General Product Information

Product	Application
tunable 655 nm Fabry-Perot Laser	Spectroscopy
for use in an External Cavity Diode Laser (ECDL)	
sealed SOT Housing	
Monitor Diode	

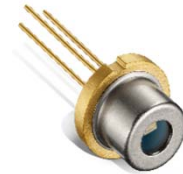

### Absolute Maximum Ratings

Parameter	Symbol	Unit	min	typ	max
Storage Temperature	$T_S$	°C	-40		85
Operational Temperature at Case	$T_C$	°C	0		20
Forward Current	$I_F$	mA			160
Reverse Voltage	$V_R$	V			0
Output Power (extracavity)	$P_{opt}$	mW			30

**Measurement Conditions / Comments**  
 Stress in excess of the Absolute Maximum Ratings can cause permanent damage to the device.

### Recommended Operational Conditions

Parameter	Symbol	Unit	min	typ	max
Operational Temperature at Case	$T_C$	°C			20
Forward Current	$I_F$	mA			160

**Measurement Conditions / Comments**

### Characteristics at $T_C =$ at 20°C, BOL under recommended working condition, with external cavity

Parameter	Symbol	Unit	min	typ	max
Center Wavelength	$\lambda_C$	nm		655	
Tuning Range	$\Delta\lambda_{tun}$	nm	650		660
Output Power	$P_{opt}$	mW		20	
Polarization				TE	
Spatial Mode (transversal)				TEM00	

**Measurement Conditions / Comments**  
 The actual achieved wavelength and power are strongly influenced by the external cavity. eyP gives no guarantee on these parameters.  
 E field parallel to Pin 2 - Pin 3 - plane  
 Fundamental Mode

# EYP-RWE-0655-00505-2000-SOT02-0000

Revision 1.00

2020-11-09

## GAIN CHIPS AR coated Fabry-Perot Laser



### Amplified Spontaneous Emission (ASE) without external cavity

Parameter	Symbol	Unit	min	typ	max
Monitor Detector Responsivity	$I_{mon} / P_{ASE}$	$\mu A/mW$	1		40

Measurement Conditions / Comments
$U_{R MD} = 5 V$

### Chip Parameter

Parameter	Symbol	Unit	min	typ	max
Cavity Length	L	$\mu m$		2000	
Reflectivity at Front Facet	$R_{ff}$			$3 \cdot 10^{-4}$	$1 \cdot 10^{-3}$

Measurement Conditions / Comments

# EYP-RWE-0655-00505-2000-SOT2-0000

Revision 1.00

2020-11-09

## GAIN CHIPS AR coated Fabry-Perot Laser

### Package Dimensions

Parameter	Symbol	Unit	min	typ	max
Height of Emission Plane	h	mm	3.50	3.65	3.70
Excentricity of Emission Center	R	mm			0.12
Pin Length	L <sub>PIN</sub>	mm		14	

### Measurement Conditions / Comments

reference plane: top side of TO header

reference: center of outer diameter of header

### Package Pinout

- 1 Laser Diode Cathode, Monitor Diode Cathode, Case
- 2 Photo Diode Anode
- 3 Laser Diode Anode

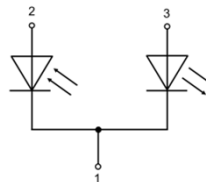

Bottom View

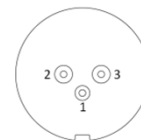

### Package Drawings

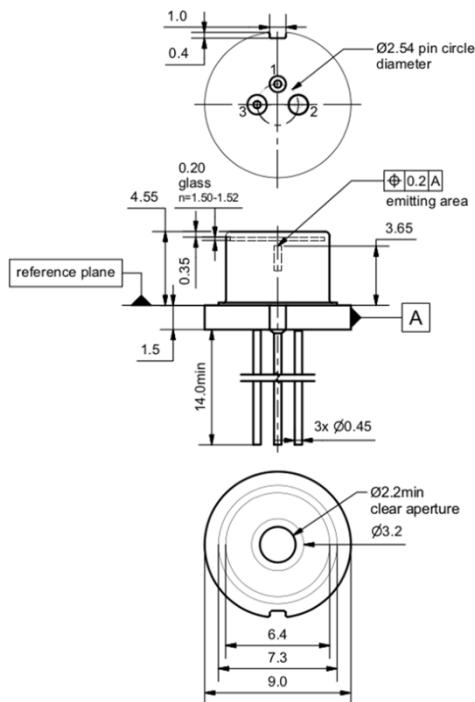

AIZ-16-0421-1517



# EYP-RWE-0655-00505-2000-SOT02-0000

Revision 1.00

2020-11-09

## GAIN CHIPS AR coated Fabry-Perot Laser

### Typical Measurement Results

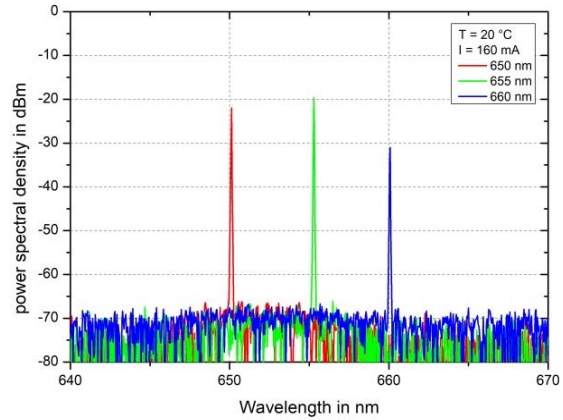
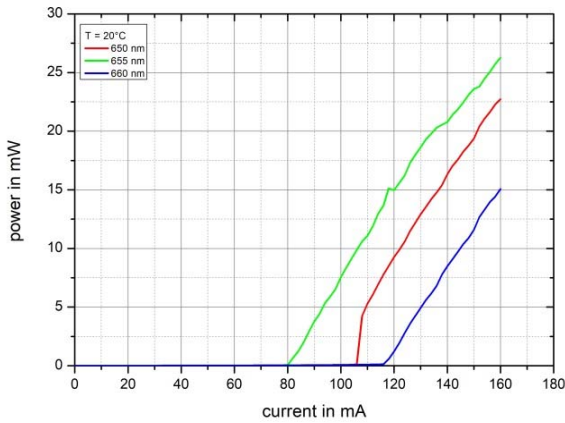

Performance figures, data and any illustrative material provided in this specification are typical and must be specifically confirmed in writing by eagleyard Photonics before they become applicable to any particular order or contract. In accordance with the eagleyard Photonics policy of continuous improvement specifications may change without notice.

### Unpacking, Installation and Laser Safety

Unpacking the laser diodes should only be done at electrostatic safe workstations (EPA). Though protection against electro static discharge (ESD) is implemented in the laser package, charges may occur at surfaces. Please store this product in its original package at a dry, clean place until final use. During device installation, ESD protection has to be maintained.

The TPA diode type is known to be sensitive against thermal stress. It should not be operated without appropriate injection from a seed laser. Operating at moderate temperatures on proper heat sinks will contribute to a long lifetime of the diode. The chip should be protected against moisture. A water vapor content below 5000 ppm is recommended for applications with high reliability requirements.

The laser emission from this diode is close to the invisible infrared region of the electromagnetic spectrum. Avoid direct and/or indirect exposure to the free running beam. Collimating the free running beam with optics as common in optical instruments will increase threat to the human eye.

Each laser diode will come with an individual test protocol verifying the parameters given in this document.

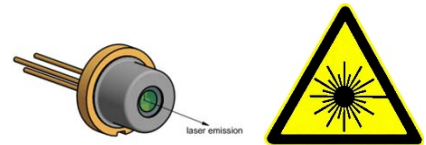

IEC-60825-0



Complies with 21 CFR 1040.10 and 1040.40